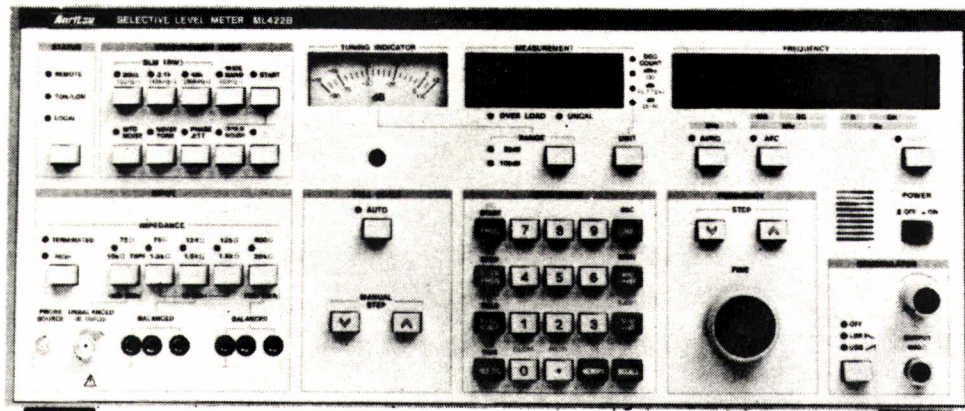

OPERATION MANUAL

SELECTIVE LEVEL METER
ML422B/C

OPERATION MANUAL

SELECTIVE LEVEL METER

ML422 B/C



CERTIFICATION

ANRITSU CORPORATION certifies that this instrument has been thoroughly tested and inspected, and found to meet published specifications prior to shipping.

Anritsu further certifies that its calibration measurements are based on the Japanese Electrotechnical Laboratory and Radio Research Laboratory standards.

WARRANTY

All parts of this product are warranted by Anritsu Corporation of Japan against defects in material or workmanship for a period of one year from the date of delivery. In the event of a defect occurring during the warranty period, Anritsu Corporation will repair or replace this product within a reasonable period of time after notification, free-of-charge, provided that: it is returned to Anritsu; has not been misused; has not been damaged by an act of God; and that the user has followed the instructions in the operation manual.

Any unauthorized modification, repair, or attempt to repair, will render this warranty void.

This warranty is effective only for the original purchaser of this product and is not transferable if it is resold.

ALL OTHER EXPRESSED WARRANTIES ARE DISCLAIMED AND ALL IMPLIED WARRANTIES FOR THIS PRODUCT, INCLUDING THE WARRANTIES OF MERCHANTABILITY AND FITNESS FOR A PARTICULAR PURPOSE, ARE LIMITED IN DURATION TO A PERIOD OF ONE YEAR FROM THE DATE OF DELIVERY. IN NO EVENT SHALL ANRITSU CORPORATION BE LIABLE TO THE CUSTOMER FOR ANY DAMAGES, INCLUDING LOST PROFITS, OR OTHER INCIDENTAL OR CONSEQUENTIAL DAMAGES, ARISING OUT OF THE USE OR INABILITY TO USE THIS PRODUCT.

All requests for repair or replacement under this warranty must be made as soon as possible after the defect has been noticed and must be directed to Anritsu Corporation or its representative in your area.

Copyright © 1985 by Anritsu Electric Co., Ltd. Printed in Japan.
All rights reserved. No part of this manual may be reproduced in any form without written permission of Anritsu Electric Co., Ltd.

Copyright © 1986 by ANRITSU CORP. Printed in Japan.
All rights reserved. No part of this manual may be reproduced in any form without written permission of ANRITSU CORP.

CONTENTS

	Page
SECTION 1 GENERAL	1-1
1.1 Introduction	1-1
1.2 Description	1-1
1.3 Safety Considerations	1-3
1.4 Storage	1-3
1.5 Installation	1-4
1.5.1 Stacking Pedestal	1-4
1.5.2 Rack Mounting	1-5
SECTION 2 COMPOSITION AND SPECIFICATIONS	2-1
2.1 Composition	2-1
2.2 Specifications	2-2
SECTION 3 OPERATION	3-1
3.1 Safety Measures	3-1
3.2 Controls and Their Functions	3-2
3.2.1 Front Panel Controls	3-2
3.2.2 Rear Panel Controls	3-17
3.3 Preliminary Instructions	3-19
3.3.1 Environmental Conditions at Installation Site	3-19
3.3.2 AC Power Cord Connection	3-19
3.4 Preparations for Measurement	3-21
3.4.1 Precautions for Measurement.....	3-21
3.4.2 "Start-up" Condition	3-22
3.5 Basic Operation	3-23
3.5.1 Frequency Setting	3-23
3.5.2 Frequency Setting based on BELL/CCITT Channel Plan	3-26
3.5.3 START Frequency, STOP Frequency and Threshold Level Setting	3-30

CONTENTS (Cont'd)

	Page
3.5.4	Threshold Level and TIME Duration Setting .. 3-30
3.5.5	Full SCALE Setting 3-31
3.5.6	Input 3-32
3.5.7	Measurement Mode 3-33
3.5.8	AFC 3-37
3.5.9	Average 3-38
3.5.10	Unit 3-38
3.5.11	Demodulator 3-39
SECTION 4	APPLICATIONS 4-1
4.1	Wideband Level Measurement 4-1
4.1.1.	Frequency Display and Setting 4-1
4.1.2	Detection System 4-1
4.1.3	Full Scale Setting 4-1
4.1.4	Unit 4-2
4.1.5	Panel Setting in WIDEBAND Mode 4-3
4.2	Selective Level Measurement 4-5
4.2.1	Selection of Bandwidth 4-5
4.2.2	Input Impedance 4-9
4.2.3	Frequency Setting and Tuning 4-9
4.2.4	Tuning by Means of AFC Function 4-10
4.2.5	Full Scale Setting 4-10
4.2.6	Unit 4-11
4.2.7	Panel Setting in Selective Mode 4-12

CONTENTS (Cont'd)

	Page
4.3	Weighted Noise Measurement 4-13
4.3.1	Frequency Setting 4-13
4.3.2	Weighting Filter 4-13
4.3.3	Unit 4-16
4.3.4	Panel Setting in Weighted Noise Mode 4-17
4.4	Noise with Tone Measurement 4-18
4.4.1	Frequency Setting 4-18
4.4.2	Notch Filter 4-19
4.4.3	Unit 4-20
4.4.4	Panel Setting in Noise Tone Mode 4-21
4.5	Phase Jitter Measurement 4-22
4.5.1	Frequency Setting 4-22
4.5.2	Residual Phase Jitter 4-23
4.5.3	Operation 4-23
4.5.4	Panel Setting in Phase Jitter Mode 4-24
4.6	Impulse Noise Measurement 4-25
4.6.1	Frequency Setting 4-25
4.6.2	Counter and Timer 4-25
4.6.3	Operation 4-26
4.6.4	Panel Setting in Impulse Noise Mode 4-27
4.7	Tone Search 4-28
4.7.1	Panel Setting in Tone Search Mode 4-29
4.7.2	Basic Operation 4-30
4.8	Modification of Input Impedance 4-32

CONTENTS (Cont'd)

	Page
SECTION 5 PERFORMANCE CHECK.....	5-1
5.1 Introduction	5-1
5.2 Reference Frequency Stability	5-8
5.3 Level Measuring Accuracy	5-10
5.4 Input Impedance	5-24
5.5 Bandwidth and Selectivity	5-33
5.6 Intrinsic Distortion Attenuation	5-37
5.7 IF Rejection	5-40
5.8 Image Rejection	5-43
5.9 Phase Jitter	5-46
5.10 Weighted Noise and Notch Filter	5-52
5.11 Impulse Noise	5-55
5.12 Tone Search	5-57
5.13 Tracking Output	5-61
5.14 External Reference Frequency Input	5-63
SECTION 6 GPIB	6-1
6.1 General	6-1
6.2 GPIB Functions	6-2
6.3 Address Setting	6-2
6.4 Device Message Syntax	6-5
6.5 GPIB System	6-11
6.6 Programming Examples	6-12
6.7 Tracking Operation	6-28

SUPPLEMENT ON FREQUENCY SETTING BASED ON FDM CHANNEL PLAN
AND NPR MEASUREMENT

Notes:

- (1) The instrument can be operated on a nominal voltage from 100 to 127 Vac or from 200 to 250 Vac.

The voltage is indicated on the rear panel when the instrument is shipped from the factory.

When you want to change the voltage, you should change the appropriate transformer taps according to the following.

"Wiring for Power Supply Changing"

- (2) In this manual, the power supply voltage and current rating are represented by ** Vac and *** A.
- (3) The relation between power supply voltage and current rating is listed below.

** Vac	*** A
100 to 127 V	3.15 A
200 to 250 V	1.6 A

Wiring for Power Supply Changing

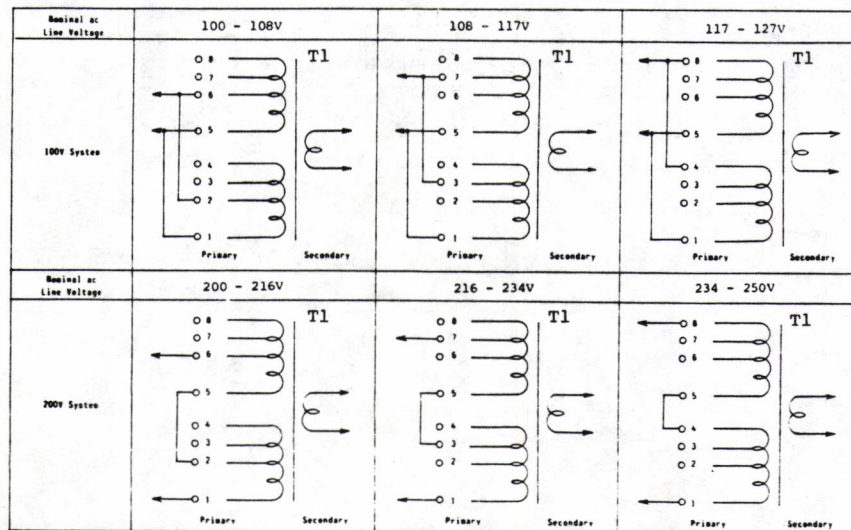

In this manual, the expression "ML422B/C" indicates that both ML422B and ML422C models are applicable in the content shown. The characteristic features of each type are shown in the following Comparison Table.

Comparison Table

Item	ML422B	ML422C
Selective Bandwidth	20 Hz (3.1 kHz + weighting filter + notch filter) 3.1 kHz + weighting filter 3.1 kHz (standard) 48 kHz group filter	20 Hz (3.1 kHz + weighting filter + notch filter) 3.1 kHz + weighting filter 3.1 kHz (standard) 48 kHz group filter
Wideband	50 Hz to 30 MHz	50 Hz to 30 MHz
Impairment measuring function	Weighting noise C-message Noise/tone ratio using notch filter Phase jitter Pub. 41009 (Bell) Impulse noise Pub. 41009 Hot tone search	Weighting noise CCITT psophometric Noise/tone ratio using notch filter Phase jitter CCITT Rec. 91 Impulse noise CCITT Rec. 71 Hot tone search
Demodulator	LSB, USB	LSB, USB
Tracking output	800 Hz to 30 MHz	800 Hz to 30 MHz
Interface	GPIB (Compatible with IEEE 488)	GPIB (Compatible with IEEE 488)
Balanced input impedance	75 Ω , 124 Ω , 135 Ω 600 Ω	75 Ω , 135 Ω , 150 Ω 600 Ω

SECTION 1
GENERAL

SECTION 1

GENERAL

1.1 Introduction

This Operation Manual is divided into six sections, each covering a particular topic concerning the operation of the ML422B and the ML422C. The topics by section number are:

Section	Topic
1	General Description and Outline of Manual
2	Composition and Specifications
3	Operation
4	Applications
5	Performance Check
6	GPIB

1.2 Description

The ML422B is designed for use with the Bell System FDM hierarchy, while the ML422C is for use with CCITT systems.

Both of these instruments cover a wide frequency range from 50 Hz to 30 MHz, providing highly accurate measurement of signal levels, with the stability of frequency needed to manufacture, install, and maintain FDM systems. The ML422B/C can also function as a wideband level meter, psophometer, or voice band analyzer.

Introduction

The ML422B/C has the ability to make both voice channel measurements and carrier frequency measurements. Furthermore, it can measure transmission impairment and search out unknown signals (hot tones). The transmission impairment measuring function allows the user to quickly troubleshoot voice channel problems with weighted noise, noise with tone, phase jitter, and single-level impulse noise measurements. The capacity to make all of the above-mentioned transmission impairment measurements, in combination with both FDM voice channel and carrier frequency measurements, is available with the ML422B/C. The ability to search out unknown signals allows the user to easily identify hot tones which exceed the threshold level.

± 0.1 dB level measuring accuracy is achieved by means of an automatic level calibration function, enabling communication systems which are evaluated by means of end-to-end measurement to be maintained at the highest level of operational standards.

The high accuracy and resolution is made possible by a synthesized local oscillator, featuring 1 Hz resolution, $\pm 5 \times 10^{-7}$ stability, and an aging rate of 1×10^{-6} /year, thus providing the ML422B/C with high-resolution tuning characteristics. The automatic frequency control (AFC) function makes tuning precise and easy, and can also be used to measure input frequencies.

This capacity for the accurate measurement of signal levels, combined with the functions of the steep channel filter (3.1 kHz) and the group filter (48 kHz) with root-mean-square (RMS) detector, permits channel noise and group power measurement without the need for additional devices

A General Purpose Interface Bus (GPIB: compatible with IEEE 488 - 1978) control is standard. Automatic operation is possible using an external controller such as the ANRITSU Packet II Hy-personal Computer (Model DDC7706C).

1.3 Safety Considerations

The symbol , which is an international symbol meaning "refer to the Operation Manual", is affixed to the operation panel of the ML422B/C. This symbol calls attention to the important operating instructions covered in Section 3.4.1, for the prevention of damage to the instrument.

1.4 Storage

(1) Storage precautions

Avoid storing this instrument for any extended period of time under the following conditions:

- ① In direct sunlight or in a dusty location.
- ② Any location where it may be exposed to water or high humidity or active gases.
- ③ Any location where oxidation may occur.
- ④ Any location having the following temperature and humidity levels:
 - . Temperature $\geq 55^{\circ}\text{C}$, $\leq -10^{\circ}\text{C}$
 - . Humidity $\geq 90\%$

(2) Precautions for equipment use after storage

Prior to using the equipment again after taking it out of storage, be sure to carry out the specified performance check.

Installation

1.5 Installation

1.5.1 Stacking Pedestal

The ML422B/C can be mounted together with the Anritsu Synthesizer/Level Generator MG443B or other Anritsu measuring instruments by means of the stacking pedestal.

Mounting diagram for stacking pedestal

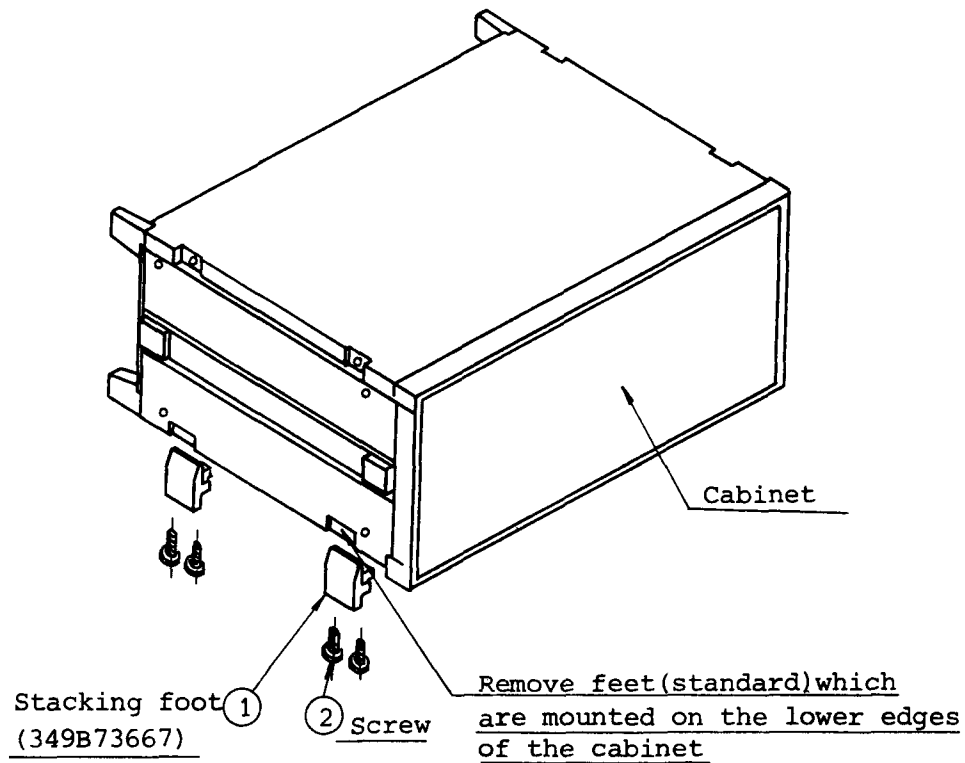

1.5.2 Rack Mounting

The ML422B/C is housed in the EIA standard 19-inch cabinet.

Assembly of rack mounting

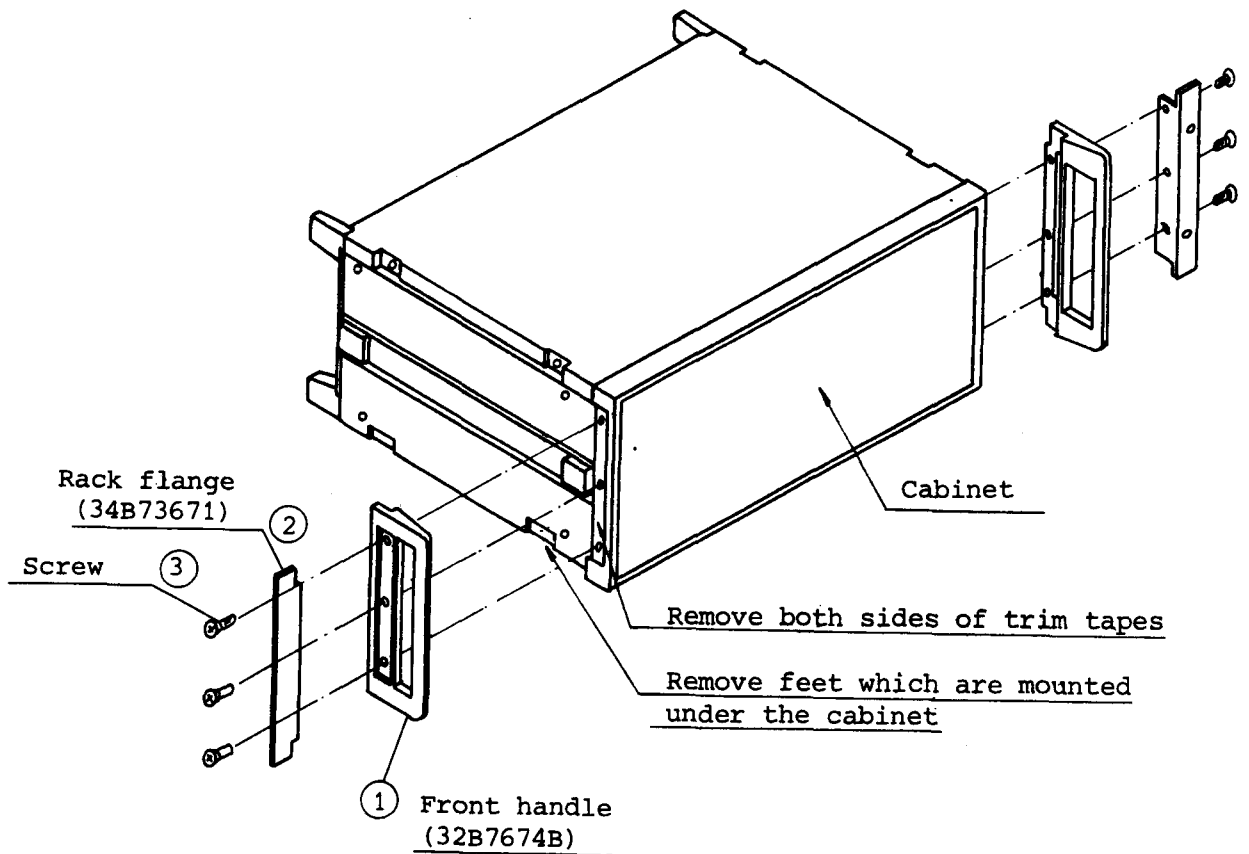

SECTION 2
COMPOSITION AND SPECIFICATIONS

SECTION 2

SECTION 2
COMPOSITION AND SPECIFICATIONS

2.1 Composition

Table 2-1 Standard Composition

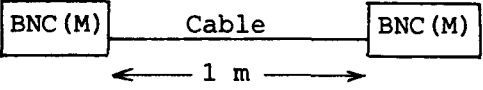
Item	Articles	Q'ty	Remarks
Instrument:	Selective Level Meter ML422B/C	1	
Accessories:	Coaxial Cable	1	
	Power Cord	1	
	Plug	1	Type 110
	Fuse	1 set	
	Operation Manual	1	
	Maintenance Manual	1	

Specifications

2.2 Specifications

Table 2-2 Specifications

Frequency range	50 Hz to 30 MHz (BW 20 Hz, WIDE BAND) 10 kHz to 30 MHz (BW 3.1 kHz) 36 kHz to 30 MHz (BW 48 kHz) 2 kHz to 2 MHz (75 Ω , 124 Ω , 135 Ω , 150 Ω BALANCED INPUT)* 50 Hz to 120 kHz (600 Ω BALANCED INPUT)			
Frequency display	LED 8 digits (minimum step: 1 Hz)			
Reference frequency stability	$\leq \pm 5 \times 10^{-7}/0 - 45^{\circ}\text{C}$, $\leq \pm 1 \times 10^{-6}/\text{year}$ (aging rate)			
Level measuring range	-120 to +30 dBm (BW 20 Hz, $f \geq 200$ Hz) -100 to +30 dBm (BW 3.1 kHz), (BW 20 Hz, $f < 200$ Hz) -80 to +30 dBm (BW 48 kHz) -60 to +30 dBm (WIDE BAND)			
Noise floor	≤ -115 dBm (BW 3.1 kHz, 75 Ω UNBALANCED, full scale ≤ -40 dBm)			
Level measuring accuracy	20 dB scale range, AFC (ON), SCALE (AUTO)			
1) 75 Ω unbalanced	(1) Selective			
	Temperature	23 $^{\circ}\text{C} \pm 5^{\circ}$	0 to 45 $^{\circ}\text{C}$	
	Frequency range	10 kHz to 13 MHz	50 Hz to 200 Hz	200 Hz to 13 MHz
	Level range		13 MHz to 30 MHz	
	0 to +20 dBm	± 0.15 dB	± 0.2 dB	± 0.15 dB
	-80 to 0 dBm	± 0.1 dB	± 0.2 dB	± 0.2 dB
	-100 to -80 dBm	± 0.3 dB	± 1 dB	± 0.5 dB
	-110 to -100 dBm	± 1 dB	± 1.5 dB	± 1.5 dB
	(2) Wide band			
	Frequency range	200 Hz to 13 MHz	13 MHz to 30 MHz	
	Level range			
	-50 to +20 dBm	± 0.3 dB	± 0.5 dB	
	-60 to -50 dBm	± 0.4 dB	± 0.6 dB	
2) Balanced	Add ± 0.1 dB to the above accuracy values 600 Ω Balanced: Not specified at ≤ 200 Hz, $\geq +10$ dBm.			

Specifications

Table 2-2 Specifications (Cont'd)

Level display	LED 5 digits, resolution: 0.01 dB (20 dB scale range) 0.1 dB (100 dB scale range) Unit: dBm, dB (0.775 V), dB(X-R, Relative to REF(R))														
Input impedance	<p>(1) Unbalanced input (75Ω)</p> <p>TERMINATED: return loss ≥ 35 dB (50 Hz to 20 MHz) ≥ 25 dB (20 to 30 MHz)</p> <p>HIGH: 10 kΩ ±10% shunted by ≤ 80 pF</p> <p>(2) Balanced input</p> <p>TERMINATED: return loss ≥ 30 dB CMRR ≥ 30 dB</p> <p>HIGH: 75Ω, 124Ω, 135Ω, 150Ω* typically 2 kΩ at 2 MHz 600Ω typically 15 kΩ at 120 kHz</p>														
Bandwidth and selectivity	<table border="1"> <thead> <tr> <th>Bandwidth</th> <th>Pass bandwidth</th> <th>Attenuation characteristic</th> </tr> </thead> <tbody> <tr> <td>20 Hz</td> <td>≥ 6 Hz (0.5 dB) 16 Hz ±20% (3 dB)</td> <td>Within ±35 Hz (45 dB) Within ±70 Hz (60 dB) Within ±2 kHz (80 dB)</td> </tr> <tr> <td>3.1 kHz</td> <td>≥ 1 kHz (0.5 dB) 3.1 kHz ±10% (3 dB)</td> <td>Within ±1.85 kHz (60 dB) Within ±2.4 kHz (70 dB)</td> </tr> <tr> <td>48 kHz</td> <td>≥ 30 kHz (0.7 dB) 48 kHz ±10% (3 dB)</td> <td>Within ±36 kHz (60 dB)</td> </tr> </tbody> </table>			Bandwidth	Pass bandwidth	Attenuation characteristic	20 Hz	≥ 6 Hz (0.5 dB) 16 Hz ±20% (3 dB)	Within ±35 Hz (45 dB) Within ±70 Hz (60 dB) Within ±2 kHz (80 dB)	3.1 kHz	≥ 1 kHz (0.5 dB) 3.1 kHz ±10% (3 dB)	Within ±1.85 kHz (60 dB) Within ±2.4 kHz (70 dB)	48 kHz	≥ 30 kHz (0.7 dB) 48 kHz ±10% (3 dB)	Within ±36 kHz (60 dB)
Bandwidth	Pass bandwidth	Attenuation characteristic													
20 Hz	≥ 6 Hz (0.5 dB) 16 Hz ±20% (3 dB)	Within ±35 Hz (45 dB) Within ±70 Hz (60 dB) Within ±2 kHz (80 dB)													
3.1 kHz	≥ 1 kHz (0.5 dB) 3.1 kHz ±10% (3 dB)	Within ±1.85 kHz (60 dB) Within ±2.4 kHz (70 dB)													
48 kHz	≥ 30 kHz (0.7 dB) 48 kHz ±10% (3 dB)	Within ±36 kHz (60 dB)													
Intrinsic distortion attenuation	Input level below 10 dBm: Single tone 2nd and 3rd order respectively ≥ 70 dB (1 kHz to 12 MHz)														
IF rejection	≥ 70 dB (56.6 MHz, Refer to full scale value) ≥ 80 dB (other frequencies)														
Image rejection	≥ 80 dB														

* ML422B : 75 Ω, 124 Ω, 135 Ω
ML422C : 75 Ω, 135 Ω, 150 Ω

Specifications

Table 2-2 Specifications (Cont'd)

<p>Phase jitter</p>	<p>Compatible with CCITT Rec. 0.91 (ML422C) and Bell Pub. 41009 (ML422B)</p> <p>(1) Input signal frequency range 1 kHz to 30 MHz</p> <p>(2) Input signal level range -60 to +10 dBm</p> <p>(3) Frequency response 20 to 300 Hz</p> <p>(4) Measuring accuracy $\pm 10\% \pm 0.5^\circ$ p-p</p> <p>(5) Residual phase jitter $\leq 0.5^\circ$ p-p</p> <p>(6) Measuring range up to 30° p-p</p> <p>(7) Resolution 0.1°</p>
<p>Weighted noise and weighting filter</p>	<p>Weighting filter is compatible with CCITT Rec. P.53 (ML422C) or Bell pub41009 C-message (ML422B) response. In selective mode, it is superimposed on the 3.1 kHz channel filter response. In wide band mode, it can be used as a normal psophometer. Notch filter rejects tone signals of 1010 Hz ± 15 Hz of over 50 dB.</p>
<p>Impulse noise</p>	<p>Compatible with CCITT Rec. 0.71 (ML422C) or Bell Pub. 41009 (ML422B).</p> <p>Time period: 1 to 99 minutes</p> <p>Threshold level setting: 1 dB step (≥ -80 dBm)</p> <p>Dead time: 125 msec. ± 25 msec. (ML422C) 143 msec. ± 25 msec. (ML422B)</p> <p>Maximum counts: 999 counts</p>
<p>Tone search</p>	<p>Automatic search for unknown signals spectral lines, or "hot" tones on transmission systems.</p> <p>Threshold level range: -100 dBm to +0 dBm (BW 3.1 kHz)</p> <p>Threshold level accuracy: ± 2 dB (scale 20 dB)</p> <p>Dynamic range: ≥ 50 dB</p>
<p>Remote control</p>	<p>Fully compatible with IEEE Standard 488-1978. Optional adapting connector for IEC 625-1 is available.</p> <p>Interface function: SH1, AH1, T5, L3, SR1, RL1 PP0, DC1, DT1, C0</p>

Specifications

Table 2-2 Specifications (Cont'd)

Demodulator	<p>Lower Side Band (LSB), Upper Side Band (USB)</p> <p>Demodulated output frequency: 300 to 3400 Hz (BW 3.1 kHz)</p> <p>Demodulated output level: Typically 0 dBm to 600 Ω (at 0 dB on tuning indicator, 75Ω UNBALANCED)</p> <p>Output connector: Suitable for SP-110</p>
Output for recorder	<p>Approx. 2 V at 0 dB on tuning indicator</p> <p>Internal resistance: Approx. 10 kΩ</p> <p>Output connector: BNC female</p>
Tracking output	<p>Frequency range: 800 Hz to 30 MHz</p> <p>Output level: 0 dBm (at 75 Ω unbalanced)</p> <p>(Tracking output cannot be used during internal calibration)</p>
External frequency reference input	<p>The internal reference oscillator can be synchronized with an external signal.</p> <p>Frequency: 1, 2, 5, or 10 MHz</p> <p>Frequency accuracy: $\pm 1 \times 10^{-6}$</p> <p>Level: 1 to 5 V p-p</p>
Input connector *1	<p>Unbalanced: BNC female</p> <p>Balanced: 3 pole CF connector x 2</p>
Power supply	<p>** Vac $\pm 10\%$, 50/60 Hz, ≤ 145 VA</p>
Ambient temperature, rated range of use	<p>0 to 45$^{\circ}$C</p>
Dimensions and Weight	<p>177 mm (H) x 426 mm (W) x 450 mm (D)</p> <p>≤ 21 kg</p>

*1 Input connector can be changed to other types such as WECO 560, 1.6/5.6, and I-214.

Specifications

OPTION NO.	SPECIFICATIONS
11	Modification of input connector (ML422B only) 75 Ω Unbalanced : WECO type 439 equivalent 124 Ω Balanced : WECO type 443 equivalent 135 Ω Balanced : WECO type 241 equivalent 600 Ω Balanced : WECO type 310 equivalent Note : 75 Ω Balanced input is removed.
12	Modification of input connector (ML422C only) Balanced input connectors are modified to I-214 type
21	Modification of balanced input frequency range (ML422B only) 124 Ω and 135 Ω balanced input frequency ranges are modified to: Frequency range: 10 kHz to 10 MHz (124 Ω), 10 kHz to 1 MHz (135 Ω) Return Loss: \geq 30 dB (124 Ω : 50 k to 5 MHz, 135 Ω : 50 k to 1 MHz) CMRR: \geq 30 dB Level measuring accuracy: \pm 0.5 dB (Selective : -80 to +10 dBm, wideband : -60 to +10 dBm) \pm 1 dB (Selective : -100 to -80 dBm) \pm 2 dB (Selective BW 20 Hz : -110 to -100 dBm) High impedance: 10 k Ω \pm 20 % at 100 kHz Note: 75 Ω balanced input is same as 135 Ω balanced.
31	Modification of selective bandwidth 400 Hz BW is installed instead of 48 kHz BW 3 dB bandwidth: 400 Hz \pm 10 % 60 dB bandwidth: \leq \pm 2 kHz Frequency range is 10 kHz to 30 MHz. Level range is -100 dB to +30 dBm.
41	Modification of FDM channel plan (ML422B only) CCITT Rec. G332 plan 1A, G343 plan 1, and G334 Plan 1 are installed instead of Bell System plan MMX2.
42	Modification of FDM channel plan (ML422C only) Bell System plan MMX2 is installed instead of CCITT Rec. G332, plan 1A, G343 plan 1, and G334 plan 1.
43	Modification of FDM channel plan CCITT Rec. G332 plan 2 is installed instead of standard plan.

SECTION 3
OPERATION

3.1 Safety Measures

- (1) The instrument is provided with 2 fuses.

These fuses are mounted on the rear panel. Fuse replacement should be performed only after disconnecting the power plug from the inlet with the POWER Switch turned off.

- (2) When operating this instrument in a room-temperature environment after using or storing it in a low-temperature environment for an extended period of time, be sure that the instrument is thoroughly dry before turning on the power, to prevent damage from short circuits caused by condensation.

Control and Their Functions

3.2 Control and Their Functions

3.2.1 Front Panel Controls

Front Panel Controls are divided into nine sections:

- (1) STATUS Control Key Section
- (2) MEASUREMENT MODE Key Section
- (3) TUNING INDICATOR and MEASUREMENT DISPLAY Section
- (4) FREQUENCY DISPLAY Section
- (5) INPUT Connector and Impedance Setting Key Section
- (6) FULL SCALE Key Section
- (7) DATA ENTRY Key Section
- (8) FREQUENCY Control Section and
- (9) DEMODULATOR Control and Power Switch Sections

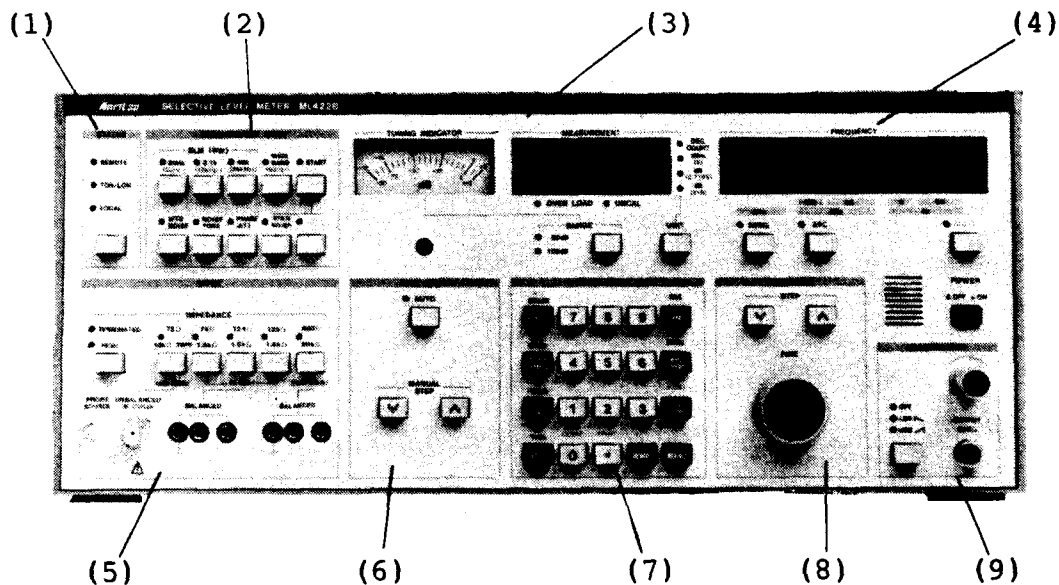
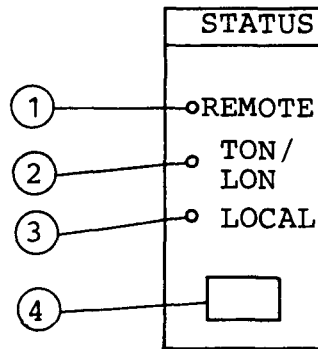



Fig. 3-1 Front Panel (ML422B)

(1) STATUS Control Key Section



No.	Indication	Description
①	o REMOTE	The Remote light indicates the operation under a remote controller.
②	o TON/LON	<p>The TON/LON light is turned on and off by the STATUS switch ④ when the GPIB address switch on the rear panel is set to TON (TALK ONLY) or LON (LISTEN ONLY) mode. The TON or LON function is active when the appropriate lamp is lit.</p> <p>TON: Outputs frequency and (level) data to peripheral instruments.</p> <p>LON: Receives frequency data from peripheral instruments and sets frequency.</p>
③	o LOCAL	The Local light indicates that the front panel settings are active. Only mode off.
④		ON/OFF key for ONLY Mode (TON, LON) of GPIB, Go to LOCAL key when under GPIB control.

Control and Their Functions

(2) Measurement Mode Key Section

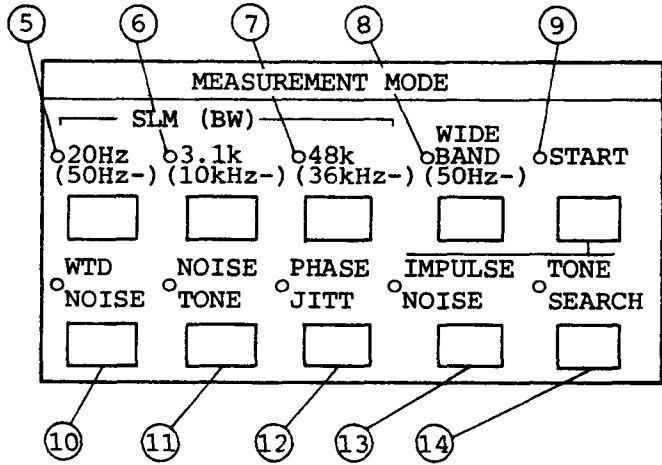

No.	Indication	Description
5	o 20 Hz (50 Hz -)	Selective bandwidth is set to 20 H. This bandwidth is effective for spectrum analysis of closely adjacent signals or pilot level measurement. Frequency range at this specification is 50 Hz to 30 MHz. However, when an input signal level is high, measurement to 20 Hz is possible.
6	o 3.1 kHz (10 kHz -)	Selective bandwidth is set to 3.1 kHz. This bandwidth is the most suitable for selecting SSB channels, and has good passband flatness and steep attenuated inclination. Frequency range at this specification is 10 kHz to 30 MHz. However, when an input signal level is high, measurement to 2 kHz is possible.
7	o 48 kHz (36 kHz -)	Selective bandwidth is set to 48 kHz. This bandwidth is the most suitable for testing FDM systems by GROUP. When signal level is high, measurement of GROUP A (CCITT channel plan), the frequency arrangement from 12 kHz to 60 kHz is possible.
8	o WIDE BAND (50 Hz -)	This switch is a wideband level measuring function which has flat frequency characteristics spread over a wide frequency range of 50 Hz to 30 MHz. Spot signal level measurements of unknown frequencies and measurements of cumulative signal levels over wide bandwidths are possible.

Control and Their Functions

(Continued)

No.	Indication	Description
⑨	o START	Allows to start and stop impulse noise and tone search measurements. When the light is on, measurement has started.
⑩	o WTD NOISE	<p>Selective mode: Selective measurement bandwidth is set to 3.1 kHz, and the noise weighting filter of the C-message/psophometric response is superimposed on the pass-band filter (3.1 kHz). Therefore the 3 dB bandwidth for noise becomes equivalent to 2 kHz (ML422B)/1.74 kHz (ML422C).</p> <p>Wide Band mode: Wide band signal is applied directly to the filter of the C-message/psophometric response.</p>
⑪	o NOISE TONE	Noise with tone is measured by inserting the notch filter and rejecting a test tone signal (1010 Hz).
⑫	o PHASE JITT	Phase jitter on a carrier is measured in accordance with Bell Pub. 41009 (ML422B), or CCITT Rec. 0.91 (ML422C).
⑬	o IMPULSE NOISE	Impulse noise is measured in accordance with Bell Pub. 41009 (ML422B), or CCITT Rec. 0.71 (ML422C).
⑭	o TONE SEARCH	Allows to search for unknown tones (Hot tones) signals which exceed the threshold level from start frequency to stop frequency, and to store the result in a frequency memory (200 waves). By using the GPIB TALK ONLY function, the result can be printed out.

Control and Their Functions

(3) Tuning and Measurement Display Section

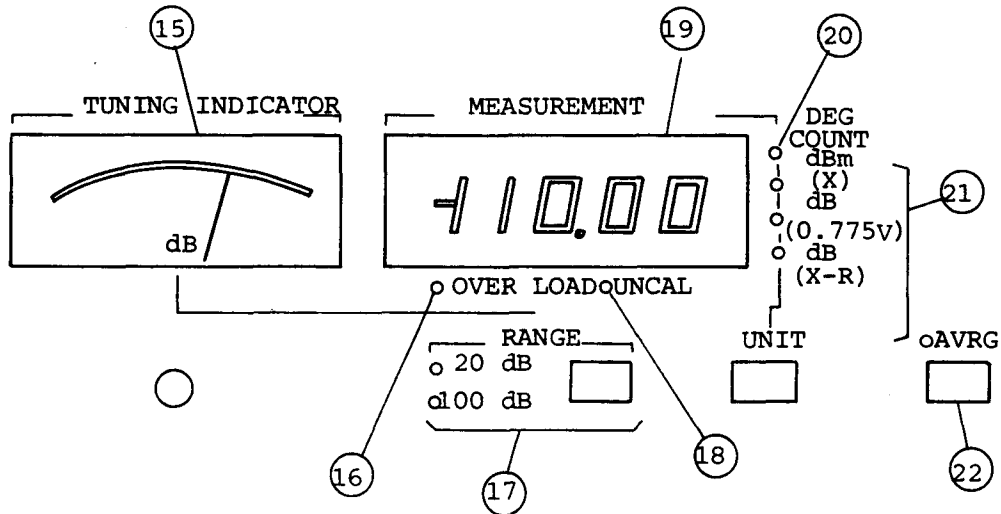

(Continued)

No.	Indication	Description
15	TUNING INDICATOR	This meter indicates the tuning condition of input signals. The range can be switched to 20 dB and 100 dB. This permits a rough reading of the input level.
16	OVER LOAD	Over Load Lamp Lights when the RF stage of the ML422B/C is over loaded. Use AUTO full scale or change full scale value to high.
17	RANGE o 20 dB o 100 dB	Selection of tuning indicator range. Tuning indicator range is 20 dB. Tuning indicator range is 100 dB.
18	UNCAL	UNCAL lamp lights when the ML422B/C is in an unstable condition or the ML422B/C is not calibrated. Measurement should be performed under the state of UNCAL to OFF.
19	MEASUREMENT	Measurements are indicated as follows:
20	o DEG, COUNT	Measurement of phase jitter and impulse noise are indicated.

(Continued)

No.	Indication	Description
<p>21</p>	<p>o dBm (X)</p> <p>o dB (0.775 V)</p> <p>o dB (X-R)</p> <p><input type="checkbox"/> UNIT</p>	<p>Input signal levels are indicated as 1 mW = 0 dBm.</p> <p>Input signal levels are indicated as 0.775 V = 0 dB.</p> <p>Input signal levels relative to a reference level (R) are indicated. Harmonic levels relative to the fundamental are easily measured by entering the measured level as the reference level (R). The operation is as follows.</p> <div style="text-align: center;"> <p><input type="checkbox"/> REF (R) → <input type="checkbox"/> MEMORY</p> </div> <p>dBm \leftrightarrow dB, dB (0.775 V) \leftrightarrow dB, and dBm \leftrightarrow dB (0.775 V) are switched. The operation of changing from dBm/dB (0.775 V) to dB (0.775 V)/dBm is as follows.</p> <div style="text-align: center;"> <p><input type="checkbox"/> SHIFT (ON) <input type="checkbox"/> UNIT</p> </div>
<p>22</p>	<p>o AVERAGE</p>	<p>In the case of phase jitter and level measurement, measured values are averaged before being displayed.</p>

Control and Their Functions

(4) Frequency Display Section

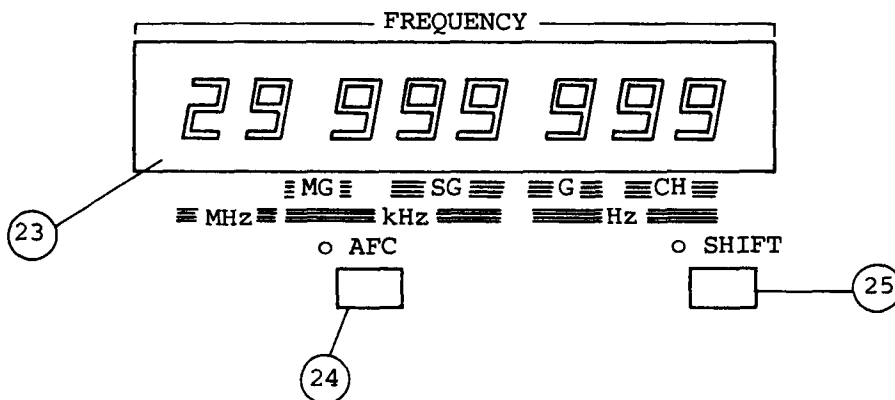

No.	Indication	Description
23	FREQUENCY	Normally selective frequency is indicated. In impulse noise mode, current time is indicated. FDM No. is indicated in channel plan entry mode.
24	o AFC	The selective frequency is automatically controlled to receive input signals at the center of the selective bandwidth.
25	o SHIFT	This advanced function key switches the control panel key functions, doubling their usefulness.

(5) Input Connector and Impedance Setting Key Section

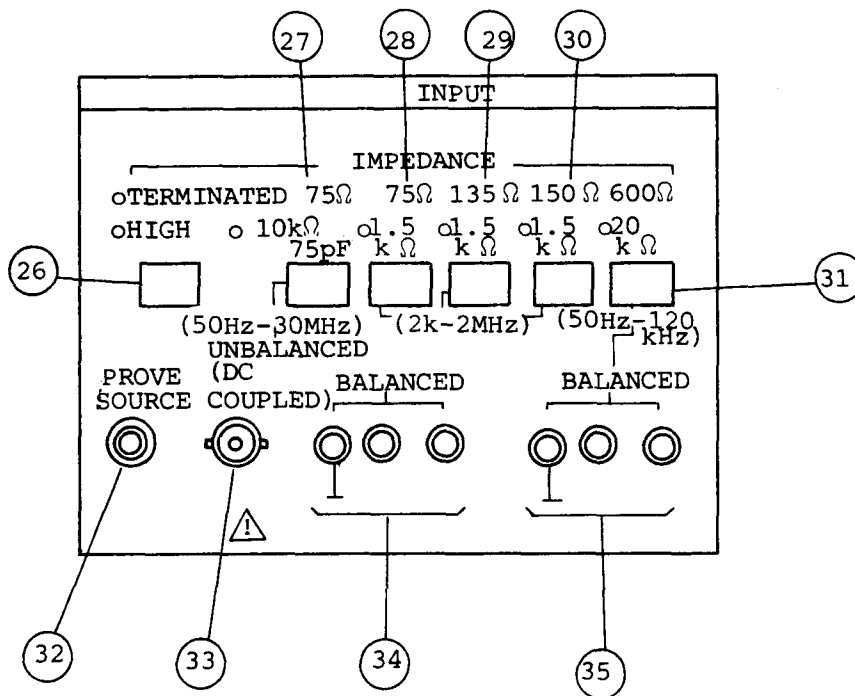

No.	Indication	Description
26	<ul style="list-style-type: none"> o TERMINATED o HIGH 	<p>TERMINATED/HIGH setting switch.</p> <p>At "TERMINATED", the input impedance is set at a nominal value. At "HIGH", the impedance value exceeds ten times of the nominal impedance.</p>
27	<ul style="list-style-type: none"> o 75Ω o 10kΩ 75pF 	<p>Impedance setting key for measuring an UNBALANCED signal ranged from 50 Hz to 30 MHz.</p> <p>The impedance is 75 Ω at TERMINATED and 10 kΩ/75pF at HIGH.</p>
28	<ul style="list-style-type: none"> o 75Ω o 1.5kΩ 	<p>Impedance setting key for measuring a BALANCED signal ranging from 2 kHz to 2 MHz.</p> <p>The impedance is 75 Ω at TERMINATED and 15 kΩ (100 kHz) at HIGH.</p>

Control and Their Functions

(Continued)



No.	Indication	Description
②9	<ul style="list-style-type: none"> ○ 124 Ω 1.5 kΩ/ML422B ○ 135 Ω 1.5 kΩ/ML422C 	<p>Impedance setting key for measuring a BALANCED signal.</p> <p>The impedance is 124 Ω for ML422B and 135 Ω for ML422C at TERMINATED, and is 15 kΩ (f = 100 kHz) at HIGH.</p>
③0	<ul style="list-style-type: none"> ○ 135 Ω 1.5 kΩ/ML422B ○ 150 Ω 1.5 kΩ/ML422C 	<p>Impedance setting key for measuring a BALANCED signal.</p> <p>The impedance is 135 Ω for ML422B and 150 Ω for ML422C at TERMINATED, and is 15 kΩ (f = 100 kHz) at HIGH.</p>
③1	<ul style="list-style-type: none"> ○ 600 Ω 20 kΩ 	<p>Impedance setting key for measuring a BALANCED signal.</p> <p>The impedance is 600 Ω at TERMINATED and 60 kΩ (f = 20 kHz) at HIGH.</p>
③2	PROBE SOURCE	Power supply terminal for High Impedance Probe MA45A.
③3	UNBALANCED (DC COUPLED)	INPUT CONNECTOR for an UNBALANCED signal ranged from 50 Hz to 30 MHz.
③4	BALANCED	INPUT CONNECTOR for a BALANCED signal ranging from 2 kHz to 2 MHz.
③5	BALANCED	INPUT CONNECTOR for a BALANCED signal ranging from 50 Hz to 120 kHz.

Note:

An input connector that is not being used to measure must always be open, or a measurement error will occur due to crosstalk.

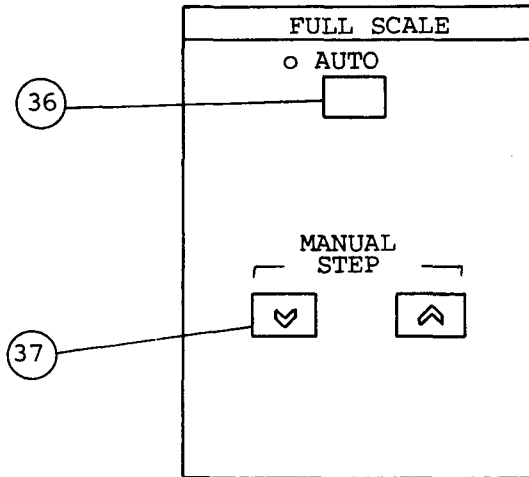
(6) FULL SCALE Key Section



No.	Indication	Description
③⑥	○ AUTO 	Sensitivity is automatically controlled depending on the total input signal level.
③⑦	MANUAL STEP  	Sensitivity is increased and decreased in 5 dB steps. Although manual control in 5 dB steps is possible even when AUTO is on, AUTO takes priority.

Control and Their Functions

(7) DATA ENTRY Key Section

Header key for turning frequency, start frequency (when tone search mode), and FDM plan master group (while SHIFT lamp on) data entry.

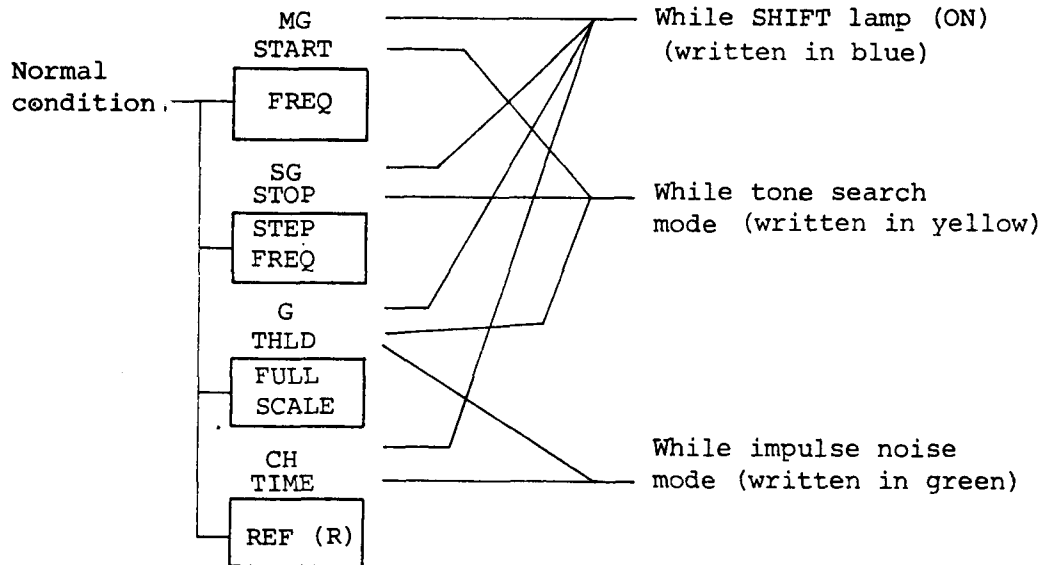

FREQ : Tuning frequency of SLM mode
STEP FREQ: Step size of frequency modification
FULL SCALE: Level of tuning indicator zero point
REF (R): Reference level of relative level measurement

MG: Master group or High group number of FDM plan
SG: Super group number of FDM plan
G: Group number of FDM plan
CH: Channel number of FDM plan

START: Start frequency of tone search
STOP: Stop frequency of tone search
THLD: Threshold level of tone search and impulse noise
TIME: Time duration of impulse noise

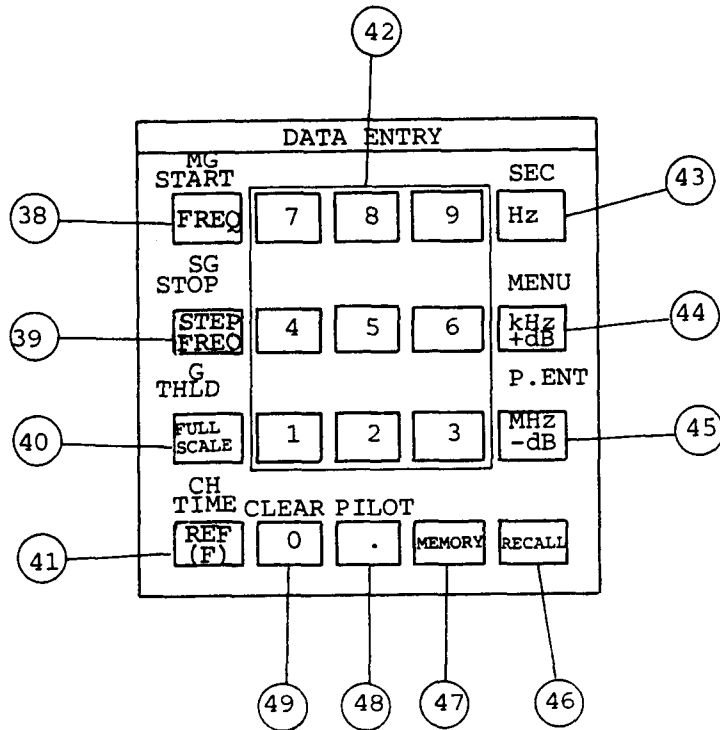



No.	Indication	Description
38	MG START FREQ	Mainly, header key for setting frequency data. FREQ key is shifted to the header key of Master Group (MG) in FDM by pressing it together with the SHIFT key. And in TONE FREQ key functions as START key in TONE SEARCH mode.
39	SG STOP STEP FREQ	Mainly, header key for setting frequency step. STEP FREQ key is shifted to the header key of Super Group (SG) in FDM by pressing it together with the SHIFT key. And STEP FREQ key functions as STOP key in TONE SEARCH mode.
40	G THLD FULL SCALE	Mainly, header key for setting a specified level range. FULL SCALE key is shifted to the header key of Group (G) in FDM by pressing it together with the SHIFT key. And FULL SCALE key functions as Threshold (THLD) key in IMPULSE NOISE mode.

Control and Their Functions

No.	Indication	Description
④1	CH TIME REF (R)	Mainly, header key for setting a reference level. REF (R) key is shifted to the header key of Channel (CH) in FDM by pressing it together with the SHIFT key. And REF (R) key functions as TIME key in IMPULSE NOISE mode.
④2	1 to 9	Numerical keys
④3	SEC Hz	Frequency unit Hz key. Hz key is shifted to the SEC key by pressing it together with the SHIFT key.
④4	MINU KHz +dB	This key functions three different ways: KHz for FREQ or STEP FREQ; +dB for FULL SCALE or REF (R); and MINU for TIME settings.
④5	P. ENT MHz -dB	This key functions three different ways: MHz for FREQ or STEP FREQ; -dB for FULL SCALE or REF (R); and FDM Plan Entry (P. ENT) for FDM channel plan setting.
④6	RECALL	This key allows recalling memory from the register in tone SEARCH mode.
④7	MEMORY	This key allows putting memory in the register in TONE SEARCH mode.
④8	Pilot .	Numeral point key. With SHIFT key on, this key functions as the Pilot key in FDM channel plan setting.
④9	CLEAR 0	Numeral Zero key. With SHIFT key on, this key functions as the CLEAR key for clearing the FDM number.

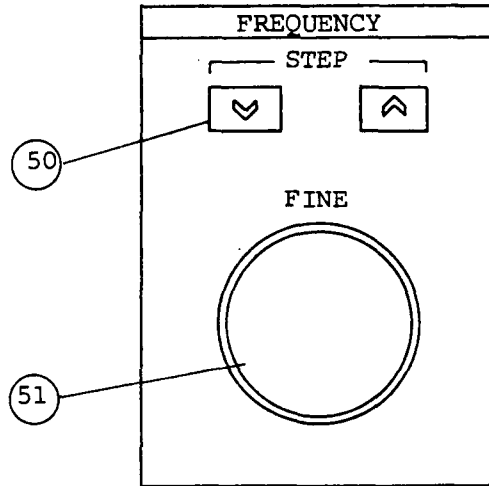
(8) Frequency Control Section



No.	Indication	Description
⑤①	<p style="text-align: center;">STEP</p> 	<p>Selective frequency is increased and decreased in steps set with STEP FREQ data entry. Repeat operation is performed by continuous pressing the STEP key. In tone search mode, measured signal levels and frequencies can be retrieved by pressing the RECALL key.</p>
⑤②	FINE	Fine adjustment of the selective frequency.

Control and Their Functions

- (9) Demodulator Control Section and Power Switch Sections
 Selection of the demodulator function of the SSB
 (Suppressed Carrier Single Sideband) channel.

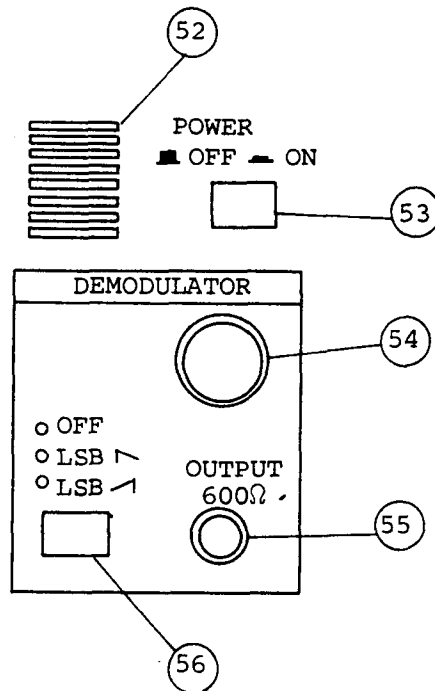

No.	Indication	Description
(52)		Speaker for the demodulated sounds.
(53)	POWER OFF <input type="checkbox"/> ON <input type="checkbox"/>	Power supply ON/OFF switch.
(54)		Volume control for demodulated signal.
(55)	OUTPUT 600 Ω	Jack for headphones to hear the demodulated output signal.
(56)	<input type="radio"/> OFF <input type="radio"/> LSB <input type="checkbox"/> <input type="radio"/> USB <input type="checkbox"/>	Demodulator function is OFF. Lower Sideband (LSB) is demodulated. Upper Sideband (USB) is demodulated.

3.2.2 Rear Panel Controls

Figure 3-2 shows the rear panel of the ML422B/C.

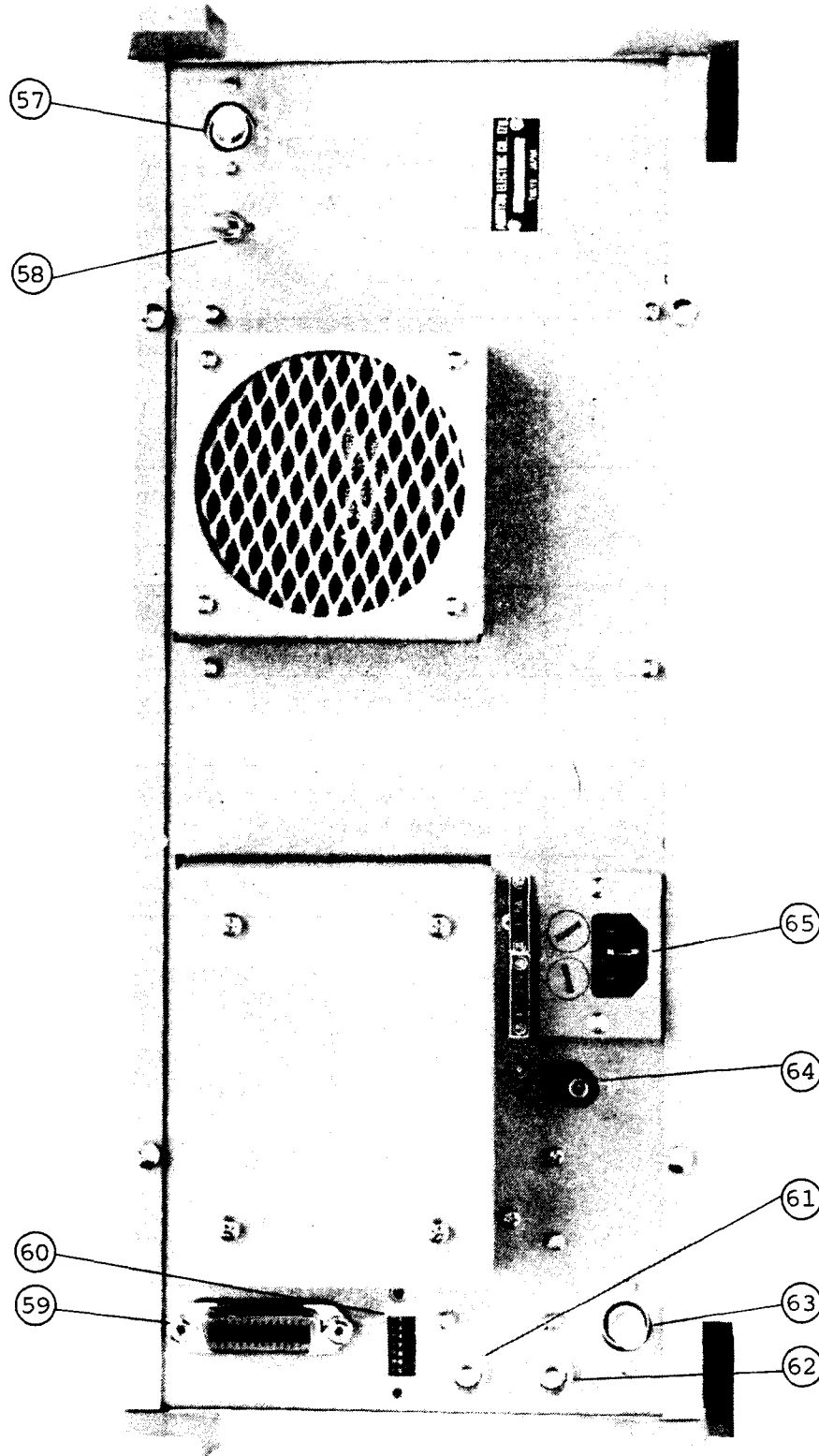

Fig. 3-2 Rear Panel

Control and Their Functions

No.	Indication	Description
⑤7	INPUT	External standard frequency input terminal for reference frequency. 1, 2, 5 or 10 MHz is acceptable.
⑤8	INT EXT	Switch for changing external standard or internal standard as the reference frequency.
⑤9	GPIB	Connector for IEEE488 Bus operation of the instrument.
⑥0	ADDRESS	GPIB address selection and ONLY mode selection switch. Used to distinguish this instrument from other devices on a bus line.
⑥1	DC OUTPUT	The DC OUTPUT terminal for a recorder. The output voltage is approx. 2 V when the meter indication is 0 dB.
⑥2	IF OUTPUT	40 kHz, in BW 48 kHz or 25 kHz in the other BW's IF OUTPUT is available.
⑥3	TRACKING OUTPUT	OUTPUT CONNECTOR for tracking with an MG443B.
⑥4	\perp	Protective ground terminal to prevent electric shock.
⑥5	FUSE ***	Fuse holder with two ***A built-in fuses.

3.3 Preliminary Instructions

3.3.1 Operating and storage conditions

This instrument is designed to operate normally in an ambient temperature range of 0° to 45°C. For best operation, however, it should be used at normal room temperature whenever possible. Do not use or store the instrument in locations

1. where vibrations are severe.
2. where it is damp or dusty.
3. where there is exposure to direct sunlight.
4. where there is exposure to active gases.
5. where there is exposure to magnetism.
6. where oxidation or rusting may occur.

The instrument should be stored in a temperature range of 0° to 45°C. It should be cleaned before storage.

The storage area should not be subject to large fluctuations in temperature over a 24-hour period.

If this instrument is operated at room temperature after being used or stored for a long period at low temperatures, condensation may occur and cause short-circuiting. To prevent this do not turn the power on until the instrument is completely dry.

3.3.2 AC Power Cord Connection

The ML422B/C normally operates on * * Vac, ±10%, 50/60 Hz. Power cord connection procedures are as follows:

Preliminary Instructions

STEP	PROCEDURE
1.	Before connecting the power cord plug to the power line/outlet, check that the supply voltage matches the specified value.
2.	After confirming that the power switch on the front panel is off, connect the power cord plug to the power source.
	WARNING: The instrument must be grounded to prevent dangerous electrical shock.
	Caution: The G terminal of the BAL input on the front panel, when used as the ground terminal of the measuring system, should not be connected to the ground potential. Otherwise, measurement error may occur due to ground current.

3.4 Preparations for Measurement

3.4.1 Precautions for Measurement

(1) Peak Voltage of Input Terminal

Confirm that the signal to be measured is less than +30 dBm.

To measure signals exceeding the above value, insert an attenuator before the input terminal to lower the level to within the specified range. To measure a signal containing a DC component, the DC current should be blocked.

(2) Precautions against Electrical Leakage

The ML422B/C is a highly sensitive instrument. Do not use it near large-capacity power equipment or high-output transmitters because errors may be caused by radiated electrical noise.

(3) Output Connection

Since the DC output of the ML422B/C is unbalanced and the input circuit of the recorder is usually balanced, the instrument must be connected as shown in Fig. 3-3.

When a shielded cable is connected to the ground terminal of the recorder, the level may vary slightly. In such a case, do not connect the shield to the terminal.

Since the DC output of the ML422B/C is about 2 V at 0 dB meter indication, the influence of external noise is very small.

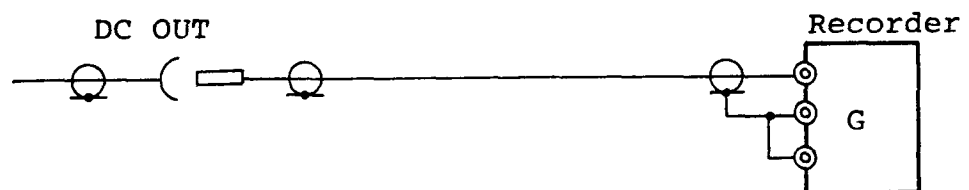
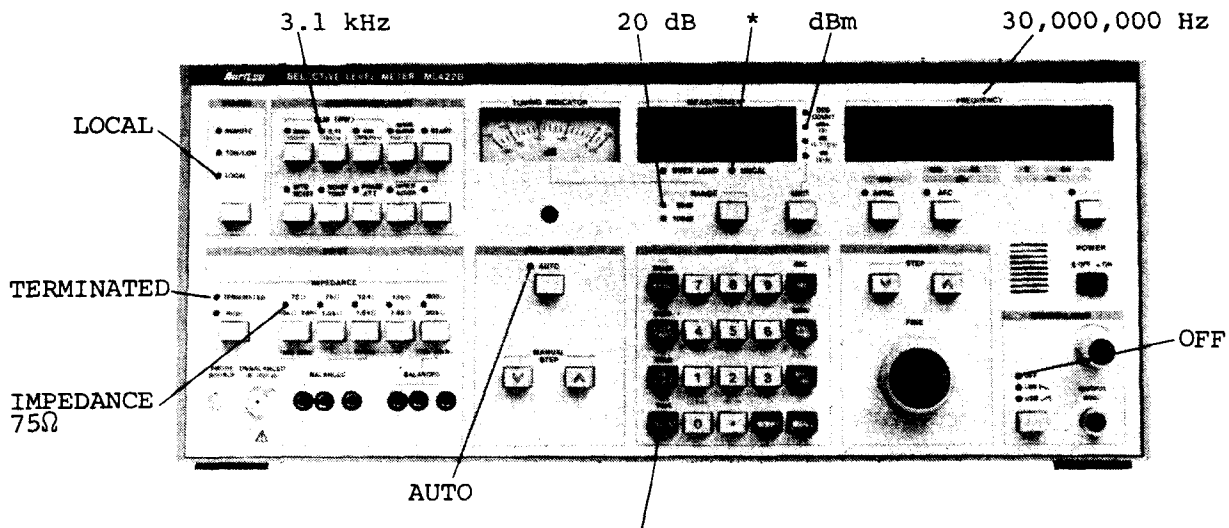

Fig. 3-3 Recorder Connection

Preparations for Measurement

3.4.2 "Start-up" Condition

The instrument is automatically set as shown in Fig. 3-4 below when the POWER switch is turned on. All corresponding lamps light up.



DATA ENTRY	FREQUENCY	30,000,000 (Hz)
	STEP FREQUENCY	4,000 (Hz)
	LEVEL RANGE	DEPEND ON AUTO RANGE
	REF LEVEL	0.00 (dB)
	START FREQ	10,000 (Hz)
	STOP FREQ	30,000,000 (Hz)
	THLD	-80 (dB)
	TIME	15 (MINU)



Note: The recommended warm-up time is 30 minutes. The UNCAL lamp will come on for a few minutes and then turn off automatically. Once UNCAL goes out, the ML422B/C can be used for reduced-accuracy measurements.

Fig. 3-4 Settings in "Start-up" Condition

3.5 Basic Operation

3.5.1 Frequency Setting

The ML422B/C is capable of various frequency setting operations, as outlined below.

- . Direct frequency setting by the DATA ENTRY keys.
- . Incremental steps - The value of the steps set by means of the STEP  and  Keys is equal to the value stored in the frequency step register.
- . Fine tuning by means of the FINE knob.
- . Frequency setting based on the Bell/CCITT channel plan.

Note: Frequency resolution is to 1 Hz. The ML422B/C ignores smaller increments.

Basic Operation

(1) Direct frequency setting

STEP	PROCEDURE
1	Press FREQ .
2	Enter the digits and decimal point as required.
3	Press Hz , kHz +dB , or MHz -dB as appropriate.

(2) Frequency step setting

STEP	PROCEDURE
1	Press STEP FREQ .
2	Enter the digits and decimal point as required.
3	Press Hz , kHz +dB , or MHz -dB as appropriate.

This value is stored in the frequency step register and maintained until the next frequency step is set or until the equipment is turned off. At turn-on, 4 kHz is set automatically.

The frequency STEP key increases the frequency and the STEP key decreases it in steps. Repeat operation is provided by pressing either key continuously for a few seconds.

(3) Fine tuning

This control provides continuous frequency entry. Frequency is increased by clockwise rotation and decreased by counter-clockwise rotation. The resolution is determined automatically by the SLM BW selection. The frequency changes are 1 Hz for the 20 Hz BW, 100 Hz for the 3.1 kHz BW, and 1 kHz for the 48 kHz BW.

AFC is a very powerful function which permits tuning to signals dominated by a single frequency component. The tuning procedure is as follows:

STEP	PROCEDURE
1	Coarse-tune the instrument.
2	Press <input type="checkbox"/> AFC once to active this function.

Basic Operation

3.5.2 Frequency Setting based on Bell/CCITT Channel Plan

The ML422B and ML422C permit frequency setting by the Bell System FDM Hierarchy MMX2, and the CCITT Rec. G332 Plan 1A, G343 Plan 1, and G334 Plan 1 respectively.

For this operation, the functions of the **FREQ** ,
STEP , **FULL** , **REF (R)** , and **MHz** keys are
FREQ , **SCALE** , **REF (R)** , and **-dB** shifted to **MG** , **SG** , **G** , **CH** and
P.ENT , respectively, by pressing the **SHIFT** key to
ON.

STEP	PROCEDURE
1	Press SHIFT (ON).
2	Press MG .
3a	Enter 0, 1, 2 or 3 (for SMG 1), 4,5 or 6 (for SMG 2) 7, 8 or 9 (for SMG 3), 10, 11 or 12 (for SMG 4) as required (ML422C).
3b	Enter 0, 1, 2, 3, 4, 5 or 6 as required (ML422B).
4	Press SG .
5a	Enter 4, 5, 6, 7, 8 or a decimal point as required (ML422C).
5b	Enter (12), 13-18, 25-28 or a decimal point as required (ML422B).
6	Press G .
7	Enter 1, 2, 3, 4, 5 or a decimal point as required
8	Press CH .
9	Enter the digits (0, 1 to 12) as required.
10	Press P.ENT .

Note: "0" is entered if no value needs to be set.

After this procedure, the demodulator is automatically set to USB/LSB in accordance with the FDM hierarchy.

(1) Pilot frequency setting

The various frequencies of the basic group pilot (ML422B: 104.08 kHz; ML422C: 84.08 kHz), basic super group pilot (ML422B: 315.92 kHz; ML422C: 411.92 kHz), and basic master group (ML422B: 2840 kHz; ML422C: 1552 kHz) and each converted frequency can be set.

Setting of basic group pilot

STEP	PROCEDURE
1	Press <input type="button" value="SHIFT"/> to turn on.
2	Press <input type="button" value="MG"/> .
3	Enter <input type="button" value="0"/> *2
4	Press <input type="button" value="SG"/> .
5	Enter <input type="button" value="0"/> .
6	Press <input type="button" value="G"/> .
7	Enter <input type="button" value="0"/> *2
8	Press <input type="button" value="CH"/> .
9	Enter <input type="button" value="PILOT"/> *1
10	Press <input type="button" value="P.ENT"/> .

Note: Steps 2 to 9 can be omitted when no setting is required.

The basic group pilot frequency at each conversion stage can be set by entering each item in Steps 4

PILOT

*1. When the key is pressed, P is displayed on the indicator, denoting that the pilot frequency is entered.

CLEAR

*2. By entering (zero), each corresponding number is cleared and the indication of the channel number becomes blank.

For the frequency setting of the basic super group pilot, enter (zero) instead of in Step 9 of

Basic Operation

the basic ^{PILOT} group pilot frequency setting mentioned above, and instead of ^{CLEAR} (zero) in Step 7.

For other settings, follow the basic group pilot frequency setting.

For the frequency setting of the basic ^{CLEAR} master group pilot, enter (zero) instead of ^{PILOT} in Step 9 of the basic ^{PILOT} group pilot frequency setting and instead of ^{CLEAR} (zero) in Step 5.

For other settings, follow the basic group pilot settings.

(2) Message channel

When a channel is selected according to the FDM channel plan and the 3.1 kHz bandwidth is also selected, the frequency is set at the center of the message portion of the channel (300 - 3400 Hz) which is 1.85 kHz from the start of the 4 kHz channel slot.

Setting of message channel

STEP	PROCEDURE
1	Select the 3.1 kHz bandwidth.
2	Press <input type="checkbox"/> SHIFT to turn on.
3	Press <input type="checkbox"/> MG .
4	Enter the significant digits as required. *1
5	Press <input type="checkbox"/> SG .
6	Enter the significant digits as required. *1
7	Press <input type="checkbox"/> G .
8	Enter the significant digits as required. *1
9	Press <input type="checkbox"/> CH .
10	Enter the significant digits as required. *1
11	Press <input type="checkbox"/> P.ENT .

Note: Steps 3 to 10 can be omitted when no setting is required.

CLEAR

*1 By entering (zero), each corresponding number is cleared and the indication of the channel number becomes blank.

(3) Signaling tone

When a frequency is set according to a channel plan and the selective bandwidth is set to 20 Hz, the resulting frequency setting corresponds to the ringer frequency (B: 2600 Hz, C: 3825 Hz.) For this method of operation select the selective bandwidth of 20 Hz and follow steps 2 through 11 of the message channel setting operation mentioned above.

(4) Group center

When a frequency is set according to a channel plan and the selective bandwidth is set to 48 kHz, the resulting frequency setting corresponds to the center frequency (84 kHz) of the basic group. For this method of operation, select the 48 kHz selective bandwidth and follow the message channel setting, except for entering ^{CLEAR} (zero) in Step 4 of the message channel setting operation mentioned above.

Note 1: Error display

When an incorrect channel plan number or its combination is entered, "CP Error" is displayed. Re-enter the correct values.

2: About more details on the frequency setting, refer to the supplement at the last of this manual.

Basic Operation

3.5.3 START Frequency, STOP Frequency and Threshold Level Setting

THE **FREQ** , **STEP FREQ** , and **FULL SCALE** keys function as **START** frequency, **STOP** frequency, and **THLD** level keys, respectively, when the ML422B/C is in TONE SEARCH mode.

STEP	PROCEDURE
1	Press TONE SEARCH .
2	Press START , STOP , or THLD as appropriate.
3	Enter the digits and decimal point as required.
4	Press Hz , kHz +dB , or MHz -dB as appropriate.

Note: The resolution of frequency and level are 1 Hz and 1 dB, respectively.

The threshold level can be changed while the ML422B/C is in IMPULSE NOISE measuring mode.

3.5.4 Threshold Level and TIME Duration Setting

The **FULL SCALE** and **REF (R)** keys function as **THLD** level and **TIME** duration keys, respectively, when the ML422B/C is in IMPULSE NOISE mode.

STEP	PROCEDURE
1	Press <input type="button" value="IMPULSE NOISE"/> .
2	Press <input type="button" value="THLD"/> or <input type="button" value="TIME"/> as appropriate.
3	Enter the digits as required.
4	Press <input type="button" value="kHz +dB"/> , <input type="button" value="MHz -dB"/> , or <input type="button" value="MINU"/> as appropriate.

Note: The resolution of level and time duration are 1 dB and 1 second, respectively.

The threshold level can be changed while the ML422B/C is in TONE SEARCH mode.

3.5.5 FULL SCALE Setting

While Automatic Full Scale is being used, the ML422B/C automatically sets the correct configuration for the optimum signal-to-noise ratio obtainable without overloading. The FULL SCALE value can be set manually in 5 dB steps by pressing the manual STEP and keys while is OFF. Although the setting can be changed manually while is on, takes priority.

Full scale entry provides direct setting over the entire scale.

Basic Operation

STEP	PROCEDURE				
1	Press <table border="1"><tr><td>FULL</td></tr><tr><td>SCALE</td></tr></table> .	FULL	SCALE		
FULL					
SCALE					
2	Enter the digits as required.				
3	Press <table border="1"><tr><td>kHz</td></tr><tr><td>+dB</td></tr></table> or <table border="1"><tr><td>MHz</td></tr><tr><td>-dB</td></tr></table> as appropriate.	kHz	+dB	MHz	-dB
kHz					
+dB					
MHz					
-dB					

Note: The resolution of full scale is 5 dB.

When full scale is entered, AUTO switches off.

The automatic full scale function is so easy to use that the operator can virtually ignore it. However, in the following cases, the automatic full scale function should be off.

- a. During manual tuning operations.
- b. During constant autoranging caused by a fluctuating input signal.
- c. During rough measurements in the 100 dB RANGE setting.

3.5.6 Input

The ML422B/C has five input impedances, each of which has a high impedance function.

TERMINATED input is used whenever the signal source needs to be terminated at a nominal impedance.

HIGH input is used whenever the impedance level of the signal being measured is already at nominal impedance. In this mode, the ML422B/C is a high-input-impedance voltmeter calibrated to read absolute signal levels in dBm or dB (0.775 V) referenced to a nominal impedance.

This relatively high impedance is often used whenever the device being tested requires bridged measurements. Typical high impedance data for the ML422B/C is shown below.

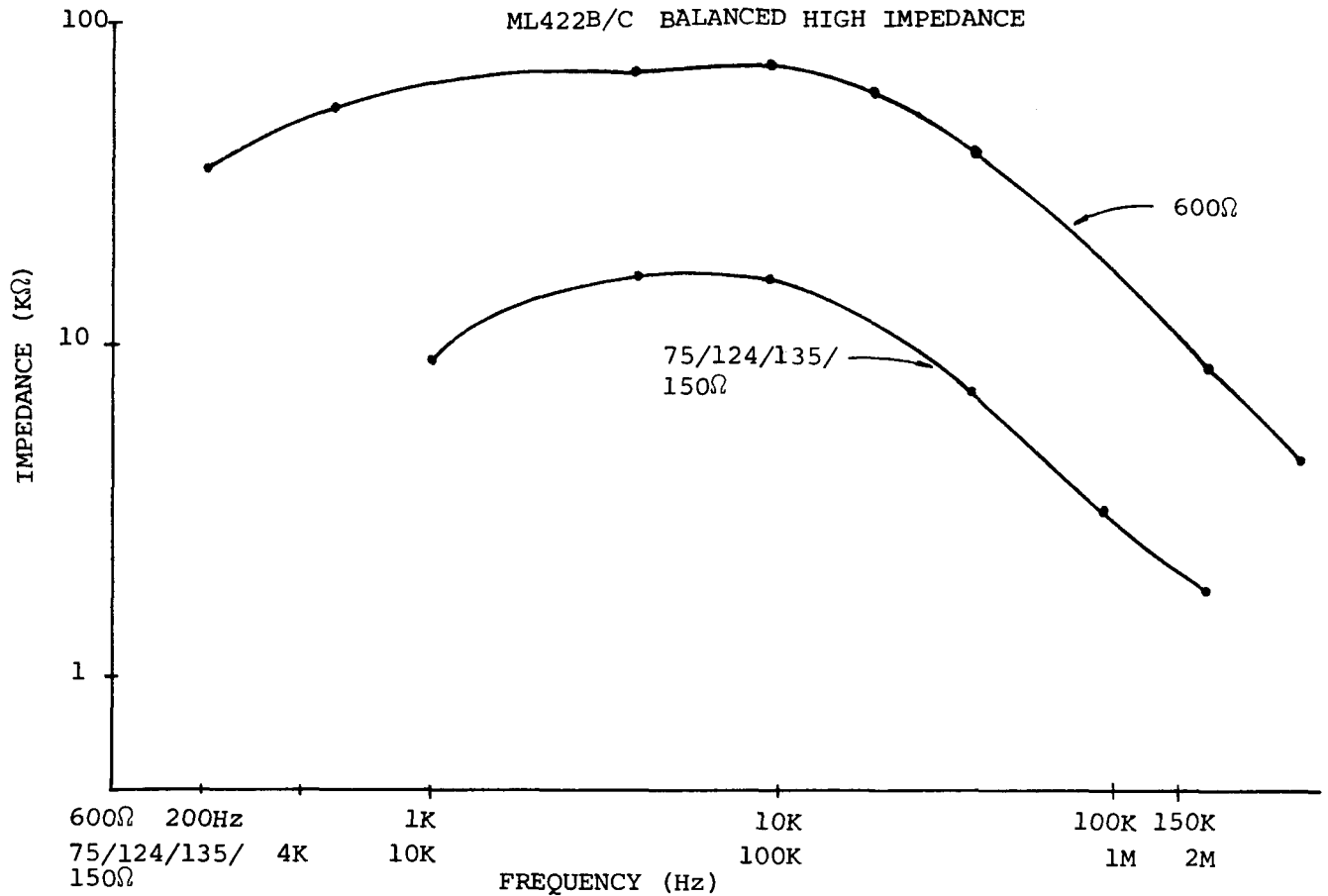

Fig. 3-3 Input impedance for 75 Ω , 124 Ω , 135 Ω , 150 Ω and 600 Ω balanced measurements

3.5.7 Measurement Mode

The ML422B/C multifunctional selective level meter provides the following specific measurements:

- . Selective measurements.
- . Wideband measurements.
- . Measurement of transmission impairments on voice channels.

Basic Operation

- . Measurement of transmission impairments on SSB channels.
- . Hot tone measurements.

(1) Selective measurements

The ML422B/C provides selective bandwidths of 20 Hz, 3.1 kHz and 48 kHz.

- Press 20 Hz For pilot level, ringer level and carrier level measurement or precise spectrum analysis.
- Press 3.1 kHz For channel power and 3.1 kHz flat noise measurement or general level measurement.
- Press 48 kHz For group power measurement.

(2) Wideband measurements

The wideband setting is used to measure the total level of the input signal. This mode is selected by pressing the WIDEBAND key. When the ML422B/C is in this mode, TONE SEARCH, AFC and DEMODULATOR are in a deactivated condition.

(3) Measurement of transmission impairments on voice channels

This type of measurement is made by combining the wideband and transmission impairment settings.

STEP	PROCEDURE
1	Press WIDEBAND .
2	Press WTD NOISE , NOISE TONE , PHASE JITT or IMPULSE NOISE as required
3*	Enter THLD level and TIME duration.
4*	Press START .

* Steps 3 and 4 are necessary for impulse noise measurements.

(4) Measurement of transmission impairments on SSB channels

This type of measurement is made by combining the selective and transmission impairment settings.

STEP	PROCEDURE
1	Press 3.1 K .
2	Enter the SSB channel frequency.
3	Set the demodulator to USB or LSB as required.
4	Press WTD NOISE , NOISE TONE , PHASE JITT , or IMPULSE NOISE as required.
5*	Enter the threshold level and TIME duration.
6*	Press START .

* Steps 5 and 6 are necessary for impulse noise measurements.

Basic Operation

(5) Hot tone measurements

This mode is functional when the ML422B/C is in the selective mode. Tones which exceed the threshold level for hot tones are identified and stored in an internal register. Up to 200 hot tones can be stored. If the ML422B/C is connected to a printer by means of a GPIB, hot tone levels and frequencies can be printed out.

STEP	PROCEDURE
1	Press <input type="text" value="20 Hz"/> , <input type="text" value="3.1 K"/> , or <input type="text" value="48 K"/> as required.
2	Press <input type="text" value="TONE SEARCH"/> .
3	Enter the START frequency, STOP frequency and <input type="text" value="THLD"/> level.
4 *1	Set the GPIB address switch to TON.
5 *1	Set STATUS to TON.
6 *2	Press <input type="text" value="START"/> (ON).
7	Wait until the START/STOP lamp turns off.
8	Press <input type="text" value="RECALL"/> .
9	Press Frequency step <input type="text" value="▲"/> or <input type="text" value="▼"/> .
10 *3	Read the data until MEASUREMENT and FREQUENCY indicates that no data remains.

*1, If a printer is connected to the ML422B/C by means of a GPIB and set to LISTEN ONLY (LON) mode, the results will be printed out on the printer.

*2, If the **SHIFT** key is pressed before the **START** key, the instrument searches out below threshold channels (Frequency only).

*3, Upon completion the indication displayed is " *End* ..."

Note: Wider bandwidths enable faster measurement than do narrower bandwidths.

Approximate time requirements are calculated by the following formula:

$$\text{TIME(sec)} = \frac{f_{\text{STOP}} - f_{\text{START}}}{f_{\text{INT}}} \times \text{S.T.} + 0.8 \times N$$

f_{STOP} = Stop frequency (Hz)

f_{START} = Start frequency (Hz)

f_{INT} = 10 Hz (when at the 20 Hz BW)

= 2000 Hz (when at the 3.1 kHz BW)

= 36000 Hz (when at the 48 kHz BW)

S.T. = 0.3 sec (when at the 20 Hz BW)

= 0.005 sec (when at the 3.1 kHz BW)

= 0.002 sec (when at the 48 kHz BW)

N = Number of hot tones

f_{INT} can be changed while in remote operation.

3.5.8 AFC

Automatic frequency control (AFC) is active when the ML422B/C is in selective mode.

After coarse tuning, if the input signal observed on the tuning indicator is 15 dB or higher than the noise level, press **AFC** once to activate this function.

Continuous AFC operation is possible by pressing **SHIFT** (ON) and **AFC** (ON) in that order.

Basic Operation

When using the AFC function, the input signal level is measured at the center. This assures more precise measurements, and easier tuning and signal frequency measurements.

3.5.9 Average (AVRG)

When the input signal is fluctuating due to noise, it is often difficult to read the digital display. By pressing **AVRG**, more precise measurements can be made. Averaging reduces the range of the random variations, but it cannot reduce a beat note created by two or more constant amplitude signals having nearly the same frequency. To obtain precise measurements in this case, other performance parameters must be traded off.

3.5.10 Unit

Units at dBm(X), dB (0.775 V) and dB (X-R) can be selected for the amplitude level shown on the MEASUREMENT display by pressing **UNIT** key together with the **SHIFT** key.

Usually the measurements are indicated in dBm (X) or dB (X-R), or, in SHIFT mode, in dB (0.775 V) or dB (X-R).

To select dBm or dB (0.775 V)

STEP	PROCEDURE
1	Press SHIFT (ON)
2	Press UNIT

Selection of dBm/dB (0.775 V) to dB (X-R) is possible by pressing the **UNIT** key only.

3.5.11 Demodulator

The demodulator is active when the ML422B/C is in the selective mode. Message channel frequencies are converted to voice channel frequencies by the internal beat frequency oscillator (BFO). The frequency of the BFO is offset ± 1.85 kHz from the intermediate frequency.

When the receiving frequency is entered according to the channel plan, the ML422B/C automatically switches to USB or LSB. However, if the receiving frequency is entered by means of a different operation, the operator must select USB or LSB in accordance with the signal being received.

SECTION 4
APPLICATIONS

4.1 Wideband Level Measurement

The wideband level is measured by pressing the WIDEBAND key. In this measurement mode, the AFC, DEMODULATOR, and TONE SEARCH functions do not operate.

4.1.1 Frequency Display and Setting

The frequency display and setting are effective for TRACKING OUTPUT signals, but are not related to the frequencies of the signals which are being measured.

4.1.2 Detection System

Since the detection system in this measurement mode uses the mean value detection system, an input signal waveform error occurs when measuring power, such as in noise measurement. Since the ML422B/C is calibrated so as to become a power display when a sine wave is entered, it must be corrected by +1.05 dB when measuring thermal noise, shot noise, or 1/f noise.

4.1.3 Full Scale Setting

Use FULL SCALE AUTO unless the special advantages of the manual mode are required. Since a frequency is not to be set in this measurement mode, levels can easily be measured by setting the FULL SCALE to AUTO. By using the manual mode when the degree of variation of the input signal level is within 20 dB (20 dB scale range) or within 40 dB (100 dB scale range), the time required for autoranging can be saved and quick measurement made possible.

Wideband Level Measurement

Note: When the 100 dB scale range is used in the manual mode, be careful not to interpret internal set noise as an input signal level.

4.1.4 Unit

Measured results are indicated in dBm when power is applied. When the unit of dB (0.775 V) is used, press the **SHIFT** and **UNIT** keys. When the unit is to be changed from dB (0.775 V) to dBm, press the **SHIFT** and **UNIT** keys again. The unit system of dBm or dB (0.775 V) can be changed into dB (X-R) in the relative value mode simply by pressing the **UNIT** key. By means of the relative value mode, conversion into another unit system, for example, dBr, dBpw, etc., or correction caused by the detection system error is easily made possible.

Note: The unit selection should be made before entering full scale.

4.1.5 Panel Setting in WIDEBAND Mode

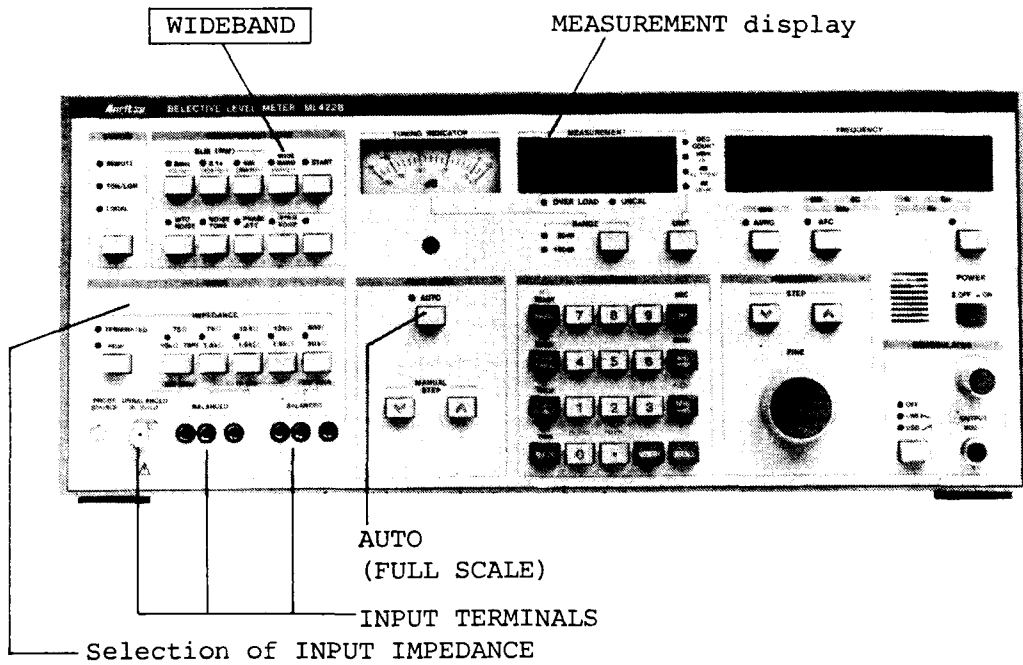

Basic Operation

STEP	PROCEDURE
1	Press WIDE BAND (on).
2	Press IMPEDANCE as required.
3	Press UNIT as appropriate.
4	Press AUTO as appropriate.

Operating procedure:

When a relative value is measured using the first measured value as a reference value, set the unit to dB (X-R) and press **REF (R)** and **MEMORY** keys.

Wideband Level Measurement

To display the reference value, press **REF (R)** key. The data is displayed on the MEASUREMENT display. To return to the MEASUREMENT mode press **Hz** key.

When making measurements using a special value as the reference value, enter as follows, using the data entry group key.

STEP	PROCEDURE
1	Press REF (R) .
2	Press NUMERAL as required.
3	Press k Hz or M Hz as required. +dB -dB

4.2 Selective Level Measurement

4.2.1 Selection of Bandwidth

The ML422B/C has selective pass bandwidths of 20 Hz, 3.1 kHz, and 48 kHz. The selection of the appropriate bandwidth depends upon the type of signal to be measured. The correct bandwidths for the signals to be measured are shown in Table 4.1.

Table 4.1

Signal to be measured	Pass bandwidth
Carrier leak	20 Hz
Pilot tone	20 Hz
Test tone	20 Hz
Ringer tone	20 Hz
Distortion	20 Hz
FM and AM signals	20 Hz
Channel power	3.1 kHz
Channel noise (non weighted)	3.1 kHz
Slot noise (non weighted)	3.1 kHz
Group power	48 kHz
Recording test for hard disk	48 kHz

Since the ML422B/C uses band-pass filters (BPF) with flat top and steep attenuation characteristics, it measures only the signals desired, rejecting adjacent signals.

The characteristics of the band-pass filters are shown in Figs. 4.1 through 4.3.

Selective Level Measurement

Bandwidth 20 Hz

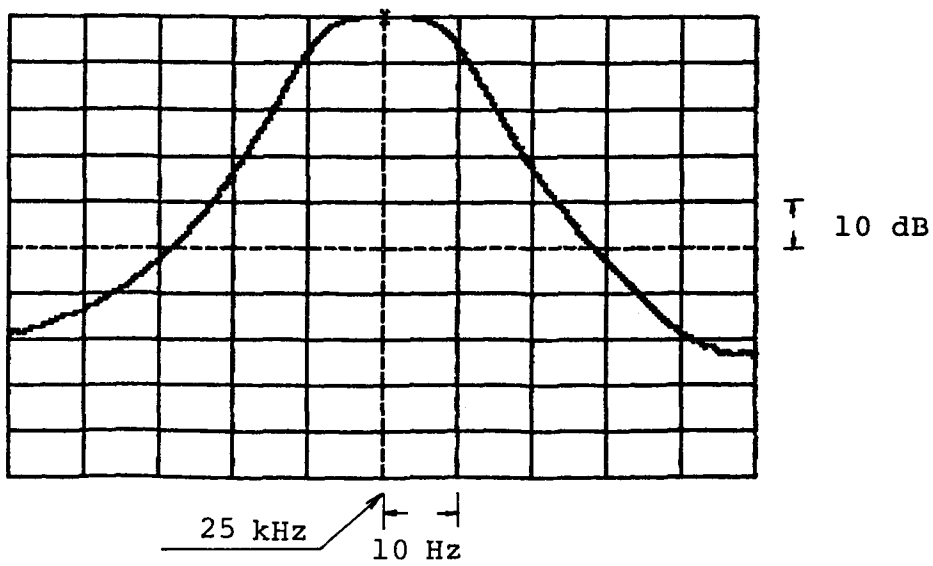

Fig. 4-1 (a)

Bandwidth 20 Hz

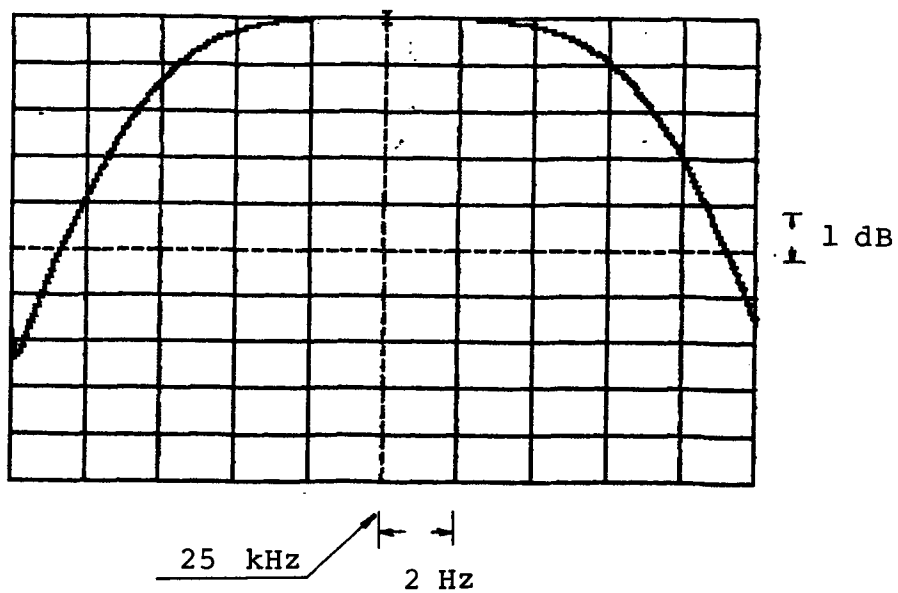

Fig. 4-1 (b)

Selective Level Measurement

Bandwidth 3.1 kHz

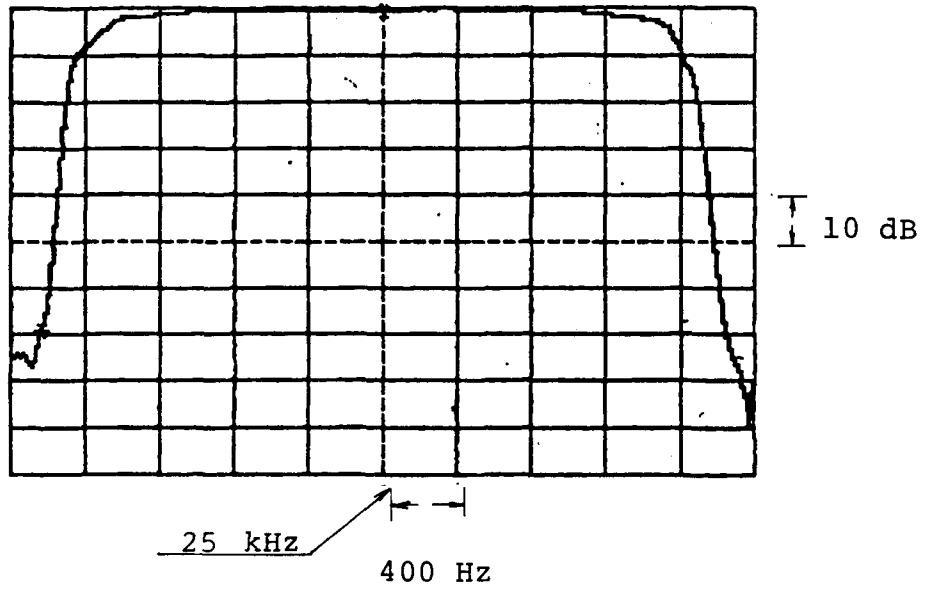

Fig. 4-2 (a)

Bandwidth 3.1 kHz

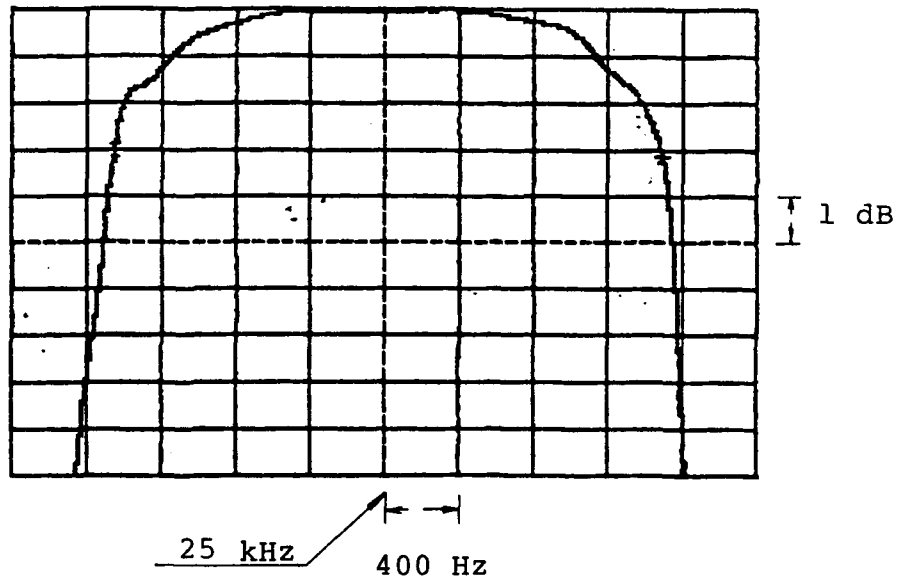

Fig. 4-2 (b)

Selective Level Measurement

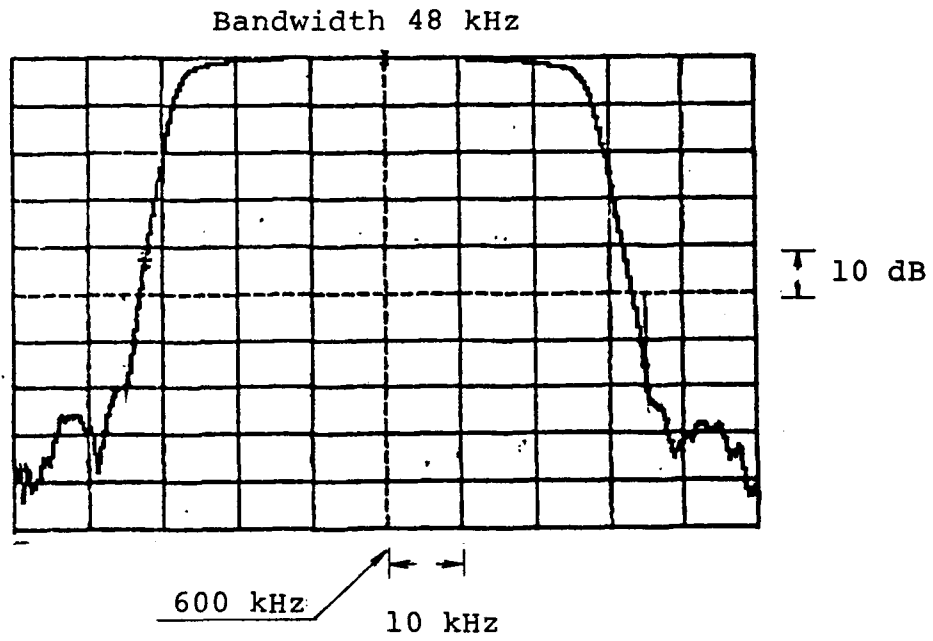

Fig. 4-3 (a)

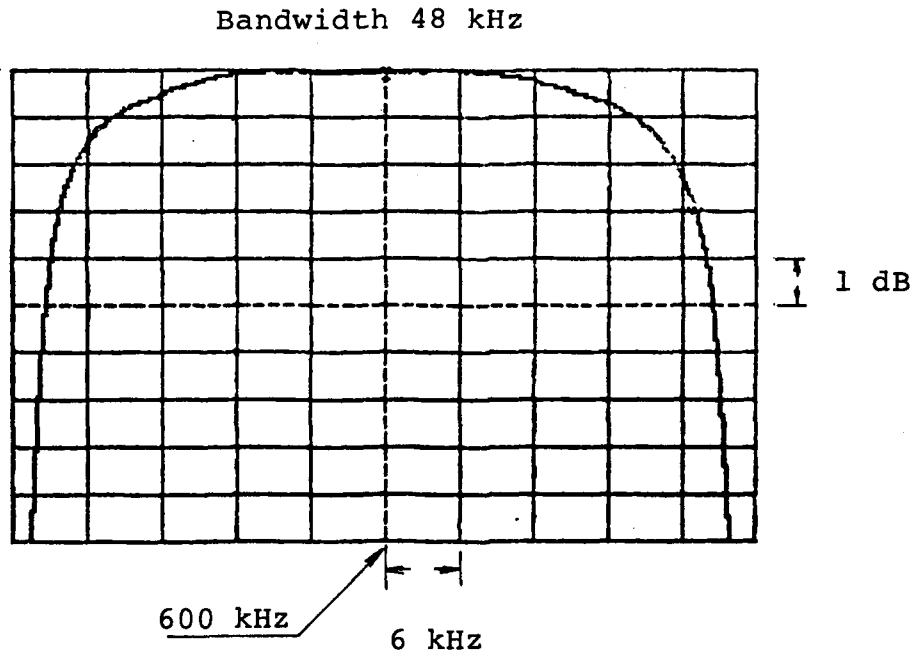

Fig. 4-3 (b)

4.2.2 Input Impedance

Select the input impedance in accordance with the test point to which the ML422B/C is being connected. For bridging operation use a high impedance. Additional information on this point is given in Par. 3.5.6.

4.2.3 Frequency Setting and Tuning

There are the various frequency settings in the ML422B/C, as described in Par. 3.5.1 and 3.5.2. In actual measurement, use them by their combination.

Note: Since the ML422B/C uses a synthesized local oscillator, the accuracy of frequency of the internal reference crystal oscillator must be considered when setting the frequency. The ML422B/C uses a crystal oscillator with a stability of $5 \times 10^{-7}/0$ to 45°C and an aging rate of $1 \times 10^{-6}/\text{year}$ as a reference. Thus, for example, when the frequency is set to 17.31192 MHz (MG6, SG13, super group pilot), an error of ± 8.656 Hz in a short period of time, or ± 17.3 Hz over an extended period of time, may occur.

For this reason, when the selective bandwidth is set to 20 Hz, accurate tuning is possible over a short period of time by using the AFC function.

Over long periods of time and when using the 20 Hz bandwidth, the fine tuning knob must be used to search a range of approximately ± 20 Hz around the set frequency.

Selective Level Measurement

To avoid this, the oscillation frequency of the internal reference crystal oscillator must be calibrated every six months, or alternatively, the use of an external reference signal with a stability of $\pm 5 \times 10^{-8}$ or more is recommended. (The ML422B/C internal reference oscillator can be tuned with 1 MHz, 2 MHz, 5 MHz and 10 MHz).

4.2.4 Tuning by means of AFC function

By using the AFC function, accurate tuning to the input signal frequency is possible. Since accurate tuning is required to accurately measure signal levels, the use of the AFC function is recommended.

Note: Since the AFC function counts the IF frequency by means of the frequency counter, operates the error from the reference value, and feeds it back to the first local, it does not function normally when there are two signals in the selective band and when the measured signal is noise or its S/N is 15 dB or less.

The AFC function can also be used with the frequency counter, since the input signal frequency is displayed on the FREQUENCY display.

4.2.5 Full Scale Setting

The full scale can be set in automatic or manual mode. In AUTO mode the full scale is set so as to obtain the optimum value by automatically controlling the RF and IF attenuators. Depending on the input signal levels, the use of AUTO mode is recommended. When the range of variation of the input signal level is within 20 dB (20 dB scale range) or when accurate measurement is required with a resolution of 0.1dB (100 dB scale range), the

autoranging time can be saved and quick measurement can be effected by setting full scale in manual mode.

4.2.6 Unit

The ML422B/C is basically operated in dBm (1 mW = 0 dBm) and dB/0.775 V (0.775 V = 0 dB).

Additionally, by switching the mode into the relative value measurement mode dB (X-R) based on the reference value, the resulting measurement is displayed as the reference value (R) instead of the measured value (X).

Note: To set the UNIT to either dB (X-R) or dB (0.775 V): The operation of the **UNIT** key alone is sufficient, and the switching operation from one unit to the other is accomplished by pressing **UNIT**, while the SHIFT lamp is in OFF position, to alternately select the desired unit.

To change from dB (X-R) \leftrightarrow dB (0.775 V) units to dB (X-R) \leftrightarrow dBm units: Press **SHIFT** so that the SHIFT lamp is ON then press **UNIT**. Each time thereafter that **UNIT** is pressed, the unit changes alternately from dB (X-R) \leftrightarrow dBm.

To return to the dB (X-R) \leftrightarrow dB (0.775 V) combination of units, press **SHIFT** again, and operate the **UNIT** key as before. (SHIFT Lamp will be in OFF position again).

Since the input full scale, REF(R), and THLD values are not set by the key operation mentioned above, the unit should be set prior to setting these values.

For example, when levels are displayed at dBm (in general, dBm 0 is used as the relative value for the standard level at the TL point represented in a unit of dBm), use the relative value measurement mode dB (X-R).

Selective Level Measurement

4.2.7 Panel Setting in Selective Mode

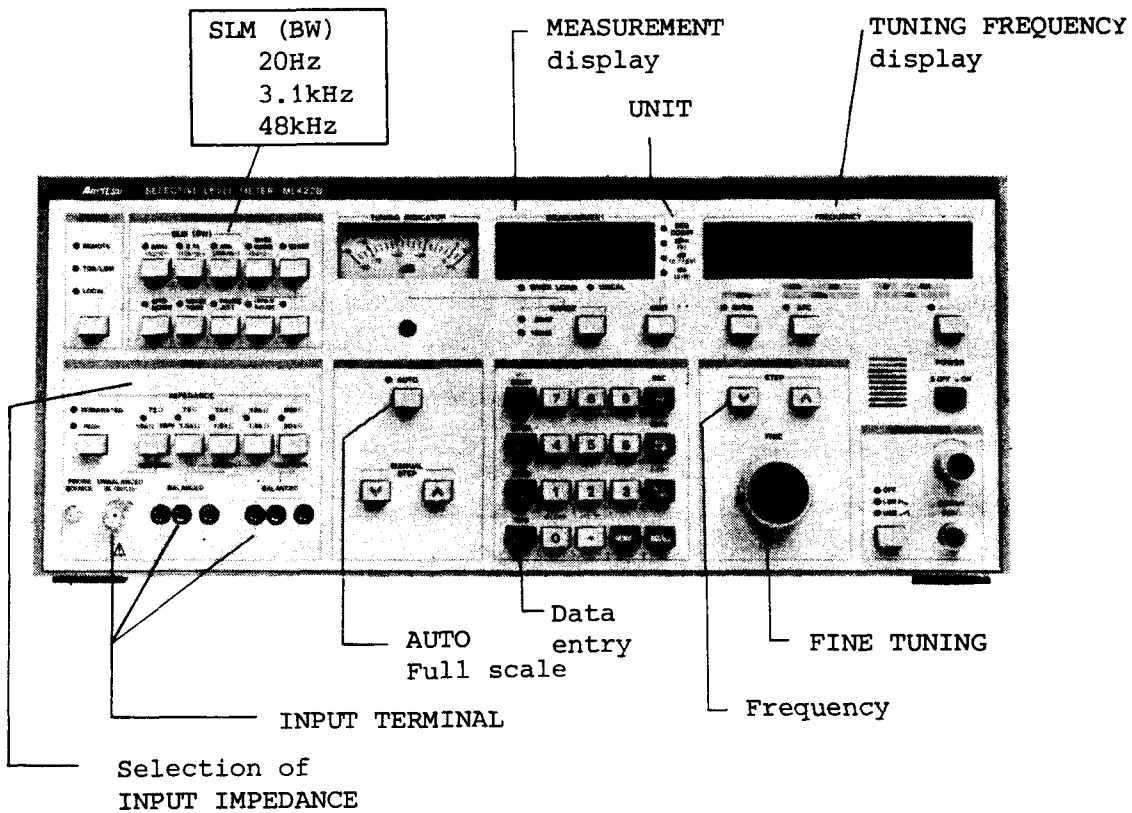

Basic Operation

STEP	PROCEDURE
1	Press SLM (BW) as required.
2	Press IMPEDANCE as required.
3	Enter the tuning frequency as required. Press FREQ . Enter the digits and decimal point as required. Press Hz , kHz or MHz . +dB -dB

4.3 Weighted Noise Measurement

In selective mode, weighted noise is measured by passing the measured signal through a 3.1 kHz band filter with a weighting filter superimposed.

(C-message/ML422 B, CCITT P.53/ML422 C).

In wideband mode, weighted noise is measured by directly passing input signals through the weighting filter.

When noise is set to **WTD NOISE** (ON) in selective mode, the selective bandwidth is automatically set to 3.1 kHz and the demodulator is set to ON (i.e., to LSB for OFF and not varied for ON).



4.3.1 Frequency Setting

In wideband mode, frequency setting is not required. When channel noise is measured in selective mode, tuning must be accurately set to the center of the message channel.

The preset frequencies are:

Carrier frequency -1.85 kHz for LSB

Carrier frequency +1.85 kHz for USB

This tuning operation can be easily carried out by setting the carrier frequency STEP FREQ to 1.85 kHz, and pressing the frequency step  or  key.

When the FDM channel plan frequency setting function is used, frequency setting is made easier by entering FDM numbers. (See Para. 3.5.4.).

4.3.2 Weighting Filter

The curves of the weighting filter used in the ML422B/C are shown in Figs. 4.4 and 4.5, respectively.

Weighted Noise Measurement

Note: In selective mode, the weighting filter is superimposed on the 3.1 kHz BPF, and the characteristics below 300 Hz and above 3.4 kHz become steeper than those shown in Figs. 4-4 and 4-5.

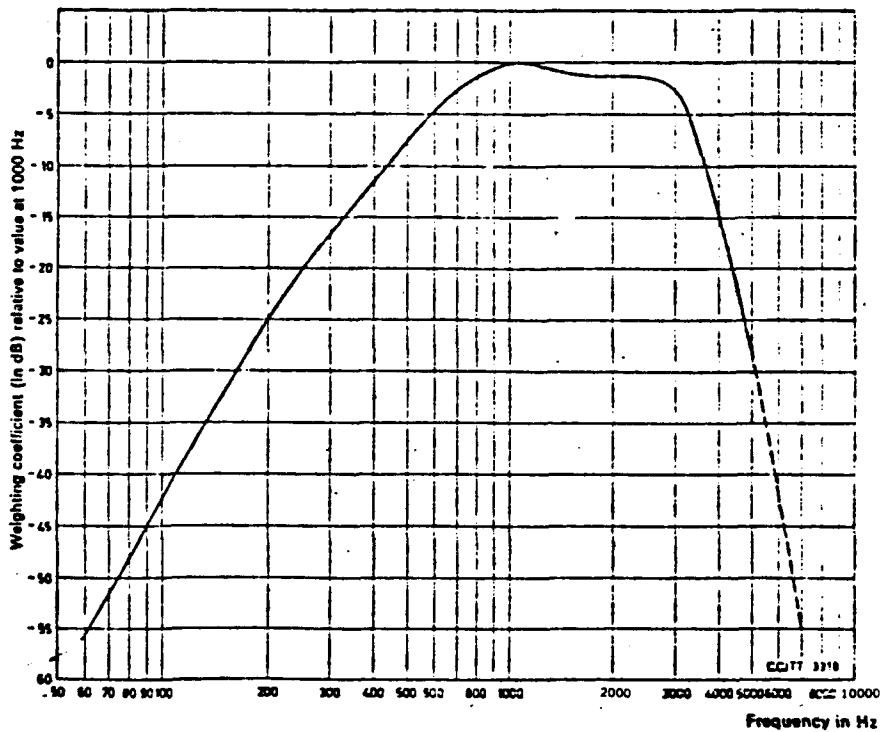

Fig. 4-4 "C message" weighting curve (ML422B)

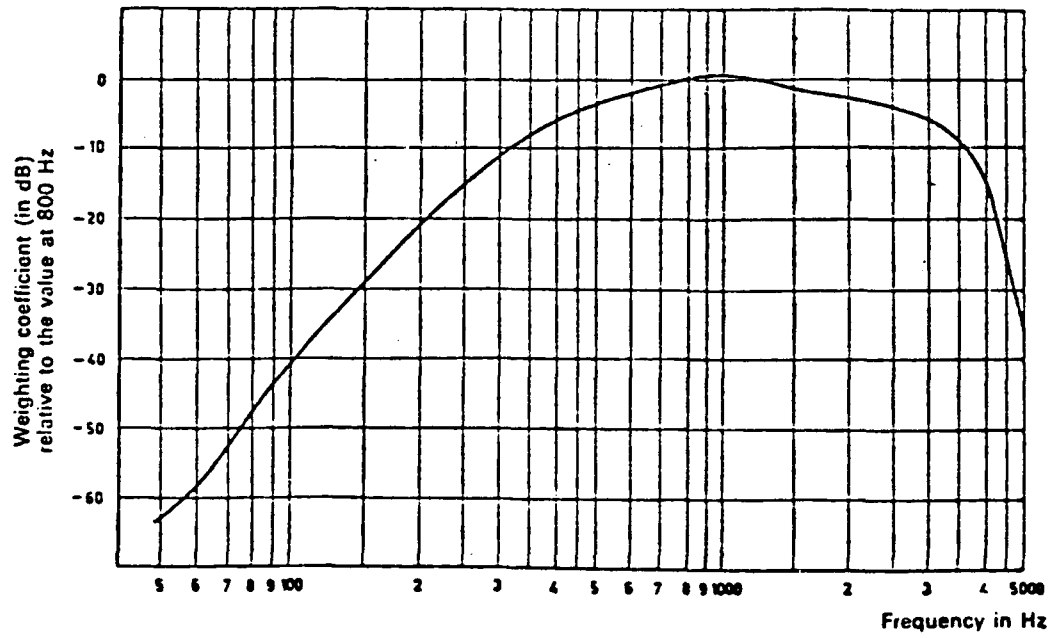

Fig. 4.5 C.C.I.T.T. psophometric weighting curve (ML422C)

Weighted Noise Measurement

4.3.3 Unit

In the case of weighted noise measurement, as for selective level measurement, the ML422B/C is operated in dBm (1 mW = 0 dBm) and dB/0.775 V (0.775 V = 0 dBm).

Additionally, by switching the mode into the relative value measurement mode dB(X-R) based on the reference value, the resulting measurement is displayed as the reference value (R) instead of the measured value (X).

Note: Refer to the note in 4.2.6.

Since the input full scale, REF(R), and THLD values are not set by the key operation mentioned above, the unit should be set prior to setting these values. For example, when levels are displayed at dBm (in general, dBm 0 is used as the relative value for the standard level at the TL point represented in a unit of dBm), use the relative value measurement mode dB(X-R).

When the relative value measurement dB(X-R) mode is used, input levels can be displayed in the dBrn and dBrnc modes normally used in noise measurement. In this case, since -90 dBm = 0 dBrn (dBrnc when weighting is applied by C-message), a unit of dBrnC/dBrnC0 is obtained by entering (, , ,) -90 in the R register.

4.3.4 Panel Setting in Weighted Noise Mode

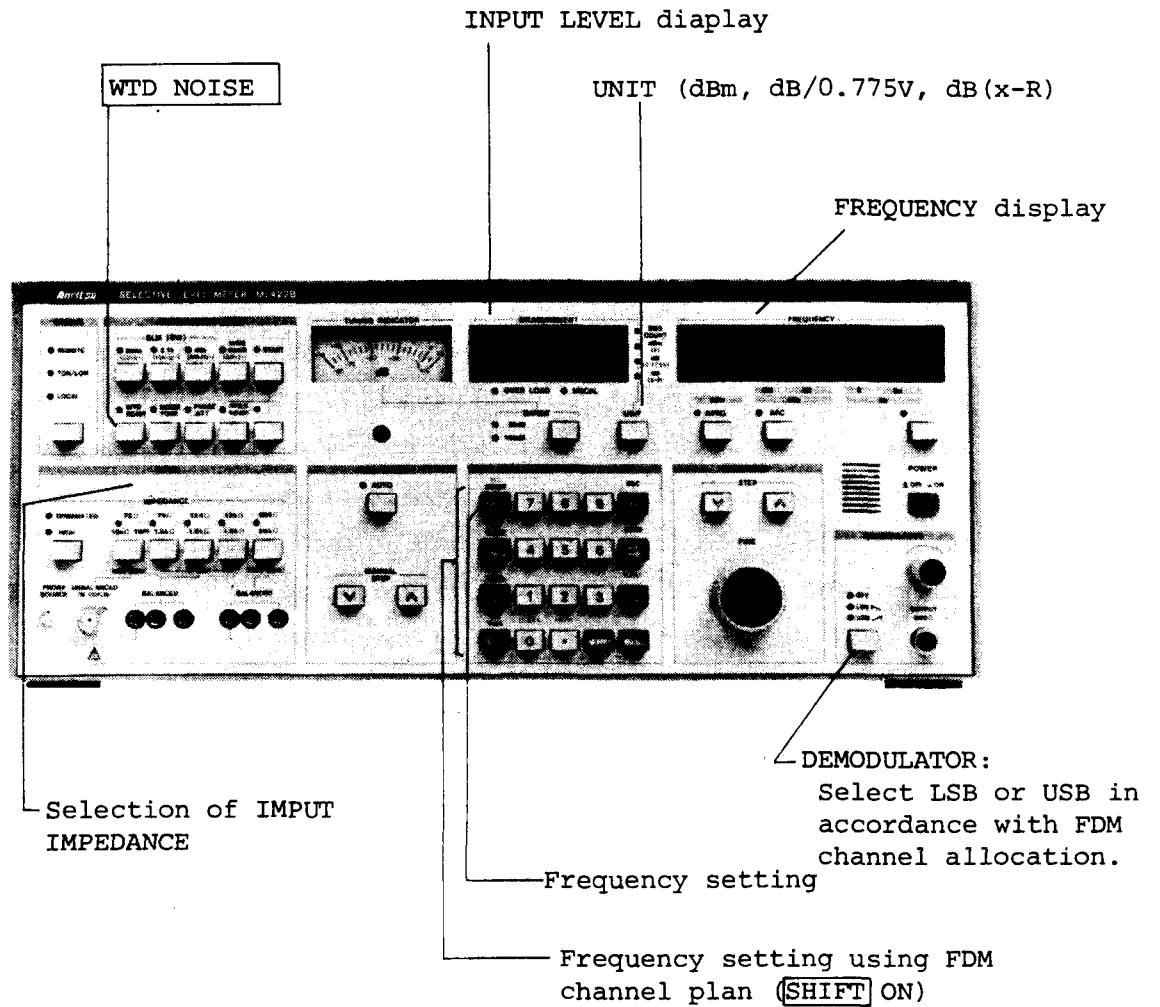

Weighted Noise Measurement

4.4 Noise with Tone Measurement

This measurement mode is used to measure the noise on the message channel containing the test tone. Since the noise is measured by removing the test tone with a notch filter, the noise under actual operating conditions can be determined. In the selective mode, the selective bandwidth is automatically set to 3.1 kHz, the AFC operates and the demodulator functions to demodulate the test tone by approximately 1 kHz.

In the wideband mode, measurements are made at the voice frequencies (0.3 - 3.4 kHz). The signal to noise ratio of a message channel can be easily measured by measuring the test tone level, then switching to the NOISE/TONE measurement mode and using the noise component and relative value measurement mode dB (X-R).



4.4.1 Frequency Setting

In wideband mode, frequency setting is not required. In selective mode, tuning must be accurately set to the center of the message channel.

The preset frequencies are:

Carrier frequency -1.85 kHz for LSB

Carrier frequency +1.85 kHz for USB

This tuning operation can be easily carried out by setting the carrier frequency STEP FREQ to 1.85 kHz, and pressing the frequency step  or  key. When the FDM channel plan frequency setting function is used, frequency setting is made easier by entering FDM numbers. (See Par. 3.5.2 (4)).

4.4.2 Notch Filter

A 1010 Hz ± 15 Hz notch filter is used to remove the test tone signal on the message channel and measure the channel noise. Fig. 4.6 shows the characteristics of this notch filter.

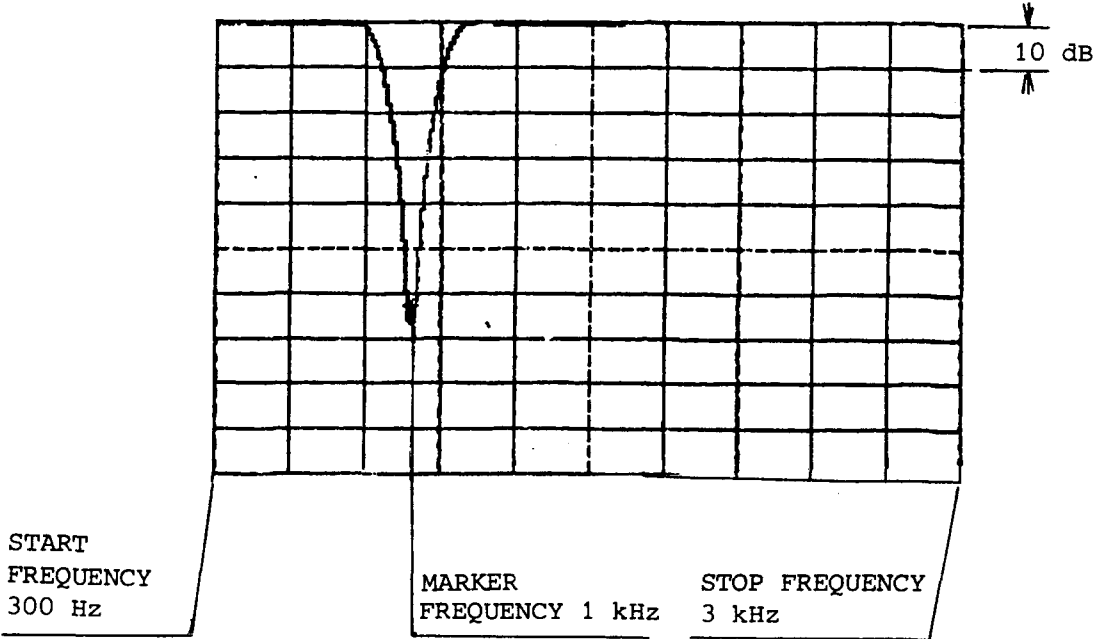

Fig. 4.6 Characteristics of notch filter

Noise with Tone Measurement

4.4.3 Unit

The ML422B/C is basically operated in dBm (1 mw = 0 dBm) and dB/0.775 V (0.775 V = 0 dB).

Additionally, by switching the mode into the relative value measurement mode dB(X-R) based on the reference value, the resulting measurement is displayed as the reference value (R) instead of the measured value (X).

Note: Refer the note in 4.2.6.

Since the input full scale, REF(R), and THLD values are not set by the key operation mentioned above, the unit should be set prior to setting these values. For example, when levels are displayed at dBm (in general, dBm 0 is used as the relative value for the standard level at the TL point represented in a unit of dBm), use the relative value measurement mode dB(X-R).

4.4.4 Panel Setting in Noise Tone Mode

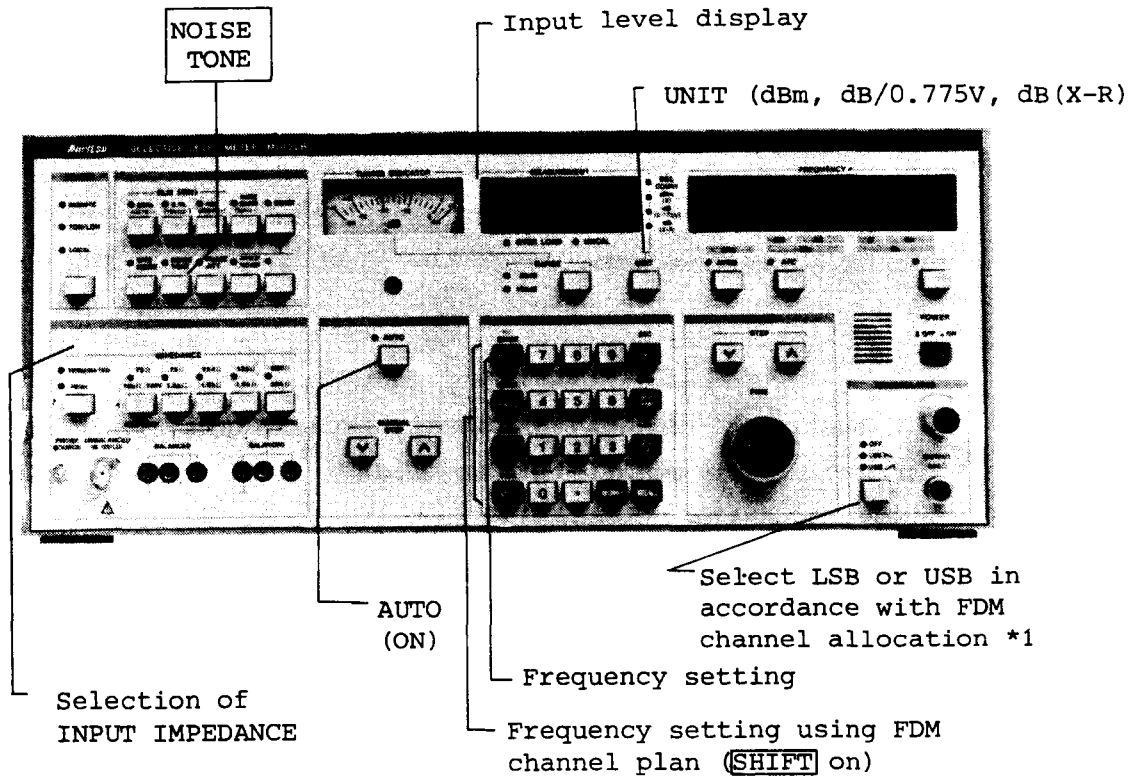

*1 When frequency setting is performed according to the FDM channel plan, switching to LSB or USB is performed automatically. When NOISE TONE is selected in the demodulator OFF setting, the demodulator is set to LSB automatically.

Phase Jitter Measurement

4.5 Phase Jitter Measurement

The ML422B/C is designed to measure the phase jitter of a 1 kHz tone signal. In the selective mode, the selective bandwidth is automatically set to 3.1 kHz, the AFC operates and the demodulator functions to demodulate the tone signal by about 1 kHz.

In the wideband mode, the phase jitter of a 1 kHz tone can be measured at the voice frequencies (0.3 - 3.4 kHz).



4.5.1 Frequency Setting

In wideband mode, frequency setting is not required. In selective mode, tuning must be accurately set to the center of the message channel.

The preset frequencies are:

Carrier frequency -1.85 kHz for LSB

Carrier frequency +1.85 kHz for USB

This tuning operation can be easily carried out by setting the carrier frequency STEP FREQ to 1.85 kHz, and pressing the frequency step  or  key. When the FDM channel plan frequency setting function is used, frequency setting is made easier by entering FDM numbers. (See Par. 3.5.2 (2)).

4.5.2 Residual Phase Jitter

Since the phase jitter is the ratio of the phase noise level and carrier level in the carrier (tone signal), the noise of the SLM itself determines the residual phase jitter. Therefore, if the input signal level is low, the residual phase jitter increases. Since the residual phase jitter is about $0 - 0.2^{\circ}$ p-p when there are no other interference signals except the signal to be measured and the input signal level is -50 dBm or greater, residual phase jitter of 0.5° p-p or less can also be measured.

4.5.3 Operation

(1) In selective mode

STEP	PROCEDURE
1	Tune the ML422B/C to a signal (or message channel).
2	Select LSB or USB as appropriate.
3	Press PHASE JITT (ON).
4	Read the measurements in deg. (p-p).

(2) In wideband mode

Simply press the PHASE JITT key to ON, and read the measurements in deg (p-p).

Note: Since the 20 Hz to 300 Hz component is measured, it takes about 4 seconds for the measured value to stabilize.

Phase Jitter Measurement

4.5.4 Panel Setting in Phase Jitter Mode

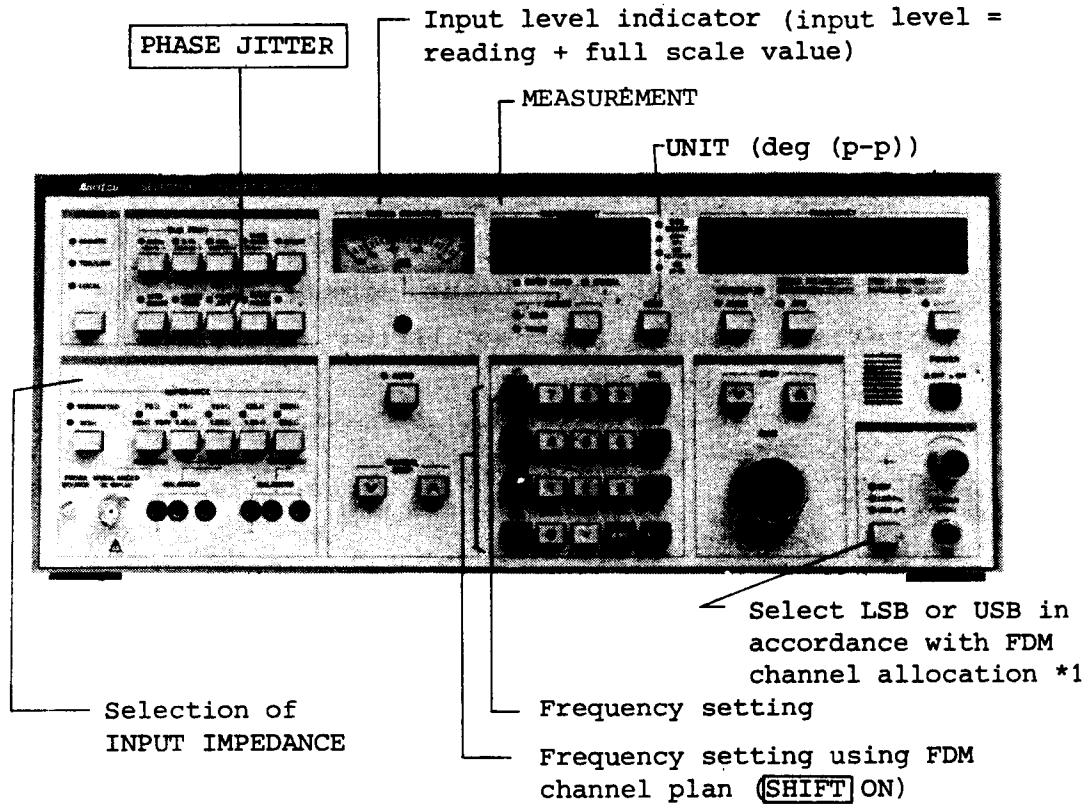

- *1 When frequency setting is performed according to the FDM channel plan, switching to LSB or USB is performed automatically. When PHASE JITTER is selected in the demodulator OFF state, the demodulator is set to LSB automatically.

4.6 Impulse Noise Measurement

The impulse noise measurement mode is used to measure the impulse noise on message channels in telecommunication systems.

Impulse noise is one of the most important test items, which give interference to data transmission. The measuring instrument requirements are recommended in CCITT Rec. 0.71 and Bell Publication 41009.

The ML422B/C is designed to measure one threshold level. When measurement is performed in the impulse noise measurement mode, the counted value is displayed on the MEASUREMENT display and the current time is displayed on the FREQUENCY display.



4.6.1 Frequency Setting

In wideband mode, frequency setting is not required. In selective mode, tuning must be accurately set to the center of the message channel.

The preset frequencies are:

Carrier frequency -1.85 kHz for LSB

Carrier frequency +1.85 kHz for USB

This tuning operation can be easily performed by setting the carrier frequency STEP FREQ to 1.85 kHz, and pressing the frequency step  or  key. When the FDM channel plan frequency setting function is used, frequency setting is made easier by entering FDM numbers. (See Par. 3.5.1 (4)).

4.6.2 Counter and Timer

The impulse noise counter can count up to 999 counts. When a count of 999 is exceeded, "oF999" is displayed.

Impulse Noise Measurement

The dead time during counting is 143 msec/ML422B and 125 msec/ML422C.

The timer can be set up to 99 minutes and 99 seconds in one second steps. When the **START** control switch is pressed, the START lamp lights up, and counting of the impulse noise begins. Counting continues up to the set time. In this case, the elapsed time is displayed on the FREQUENCY display in the form 12" 34' (12 minutes 34 seconds). To stop the count, press the **START** control switch again. The START lamp goes off. Other keys are locked while the START lamp is lit to protect against misoperation.

4.6.3 Operation

(1) In selective mode

STEP	PROCEDURE
1	Set the frequency to the message channel.
2	Select LSB or USB as appropriate.
3	Press IMPULSE NOISE (ON).
4	Press THLD ; the current threshold level is displayed.
5	Enter the digits as required.
6	Press kHz +dB or MHz -dB as appropriate.
7	Press TIME ; the current time entry is displayed.
8	Enter the digits and decimal point as required.
9	Press SEC or MINU as appropriate.
10	Press START to ON position.

Time entry

Threshold entry

(2) In wideband mode

Use the same procedure as 3 through 10 above.

4.6.4 Panel Setting in Impulse Noise Mode

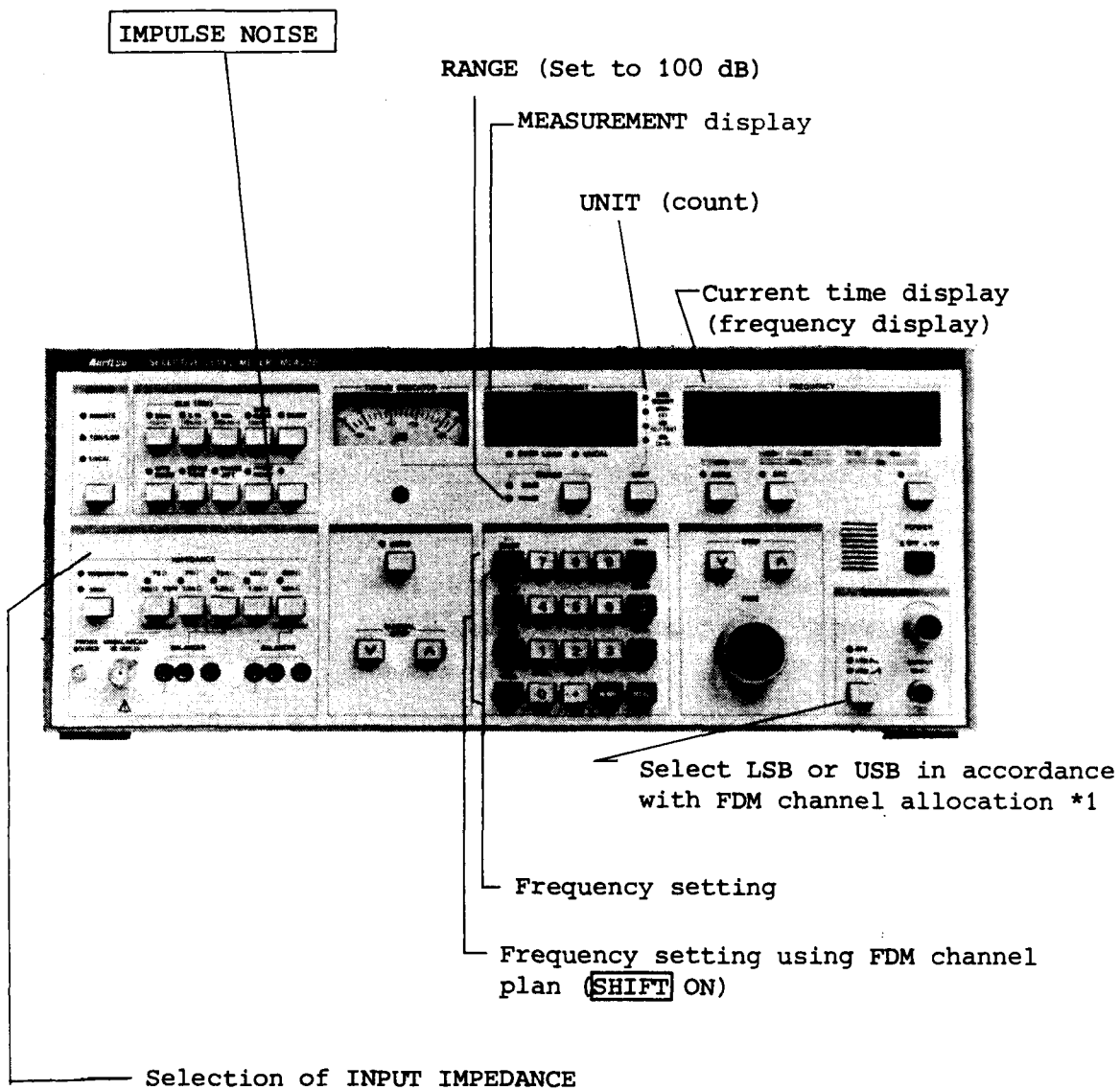

*1 When frequency setting is performed according to the FDM channel plan, switching to LSB or USB is performed automatically. When IMPULSE NOISE is selected in the demodulator OFF state, the demodulator is set to LSB automatically.

Tone Search

4.7 Tone Search

When unknown signals or a number of signals are to be measured sequentially, the tone search function is used. The ML422B/C sequentially sweeps over the start to stop frequency range in a certain step size linked to the selective bandwidth, and detects signals which exceed the threshold level. The ML422B/C then displays the signal levels and frequencies and stores these data in the internal memory register. When the ML422B/C is connected to the printer through the GPIB, it can print out the signal levels and frequencies. The contents stored in the internal memory register can be recalled as required.

Note: The maximum number of tones which can be stored in the internal memory register is 200. When the number of tones exceeds 200, the search function stops before finding the tone signal. In this case, clear the contents of the internal memory register by the key operation of

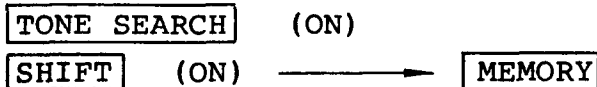

To obtain the maximum memory capacity, the above-mentioned operation is recommended before starting measurement. Furthermore, when the power is turned on, the register is cleared.

There are two modes in the tone search function. One mode is for search of high level tones which exceed the threshold level. The other mode is for search of low level channels which do not exceed the threshold level (this applies to the case where the mode is set to **START** ON in **SHIFT** ON status). In either mode, search is stopped immediately by pressing the **START** or **TONE SEARCH** control to OFF

status. After search is stopped by **START** control, continuing measurement is carried out by pressing **START** control. Other keys are locked while **START** lamp is lit, to protect against misoperation.

4.7.1 Panel Setting in Tone Search Mode

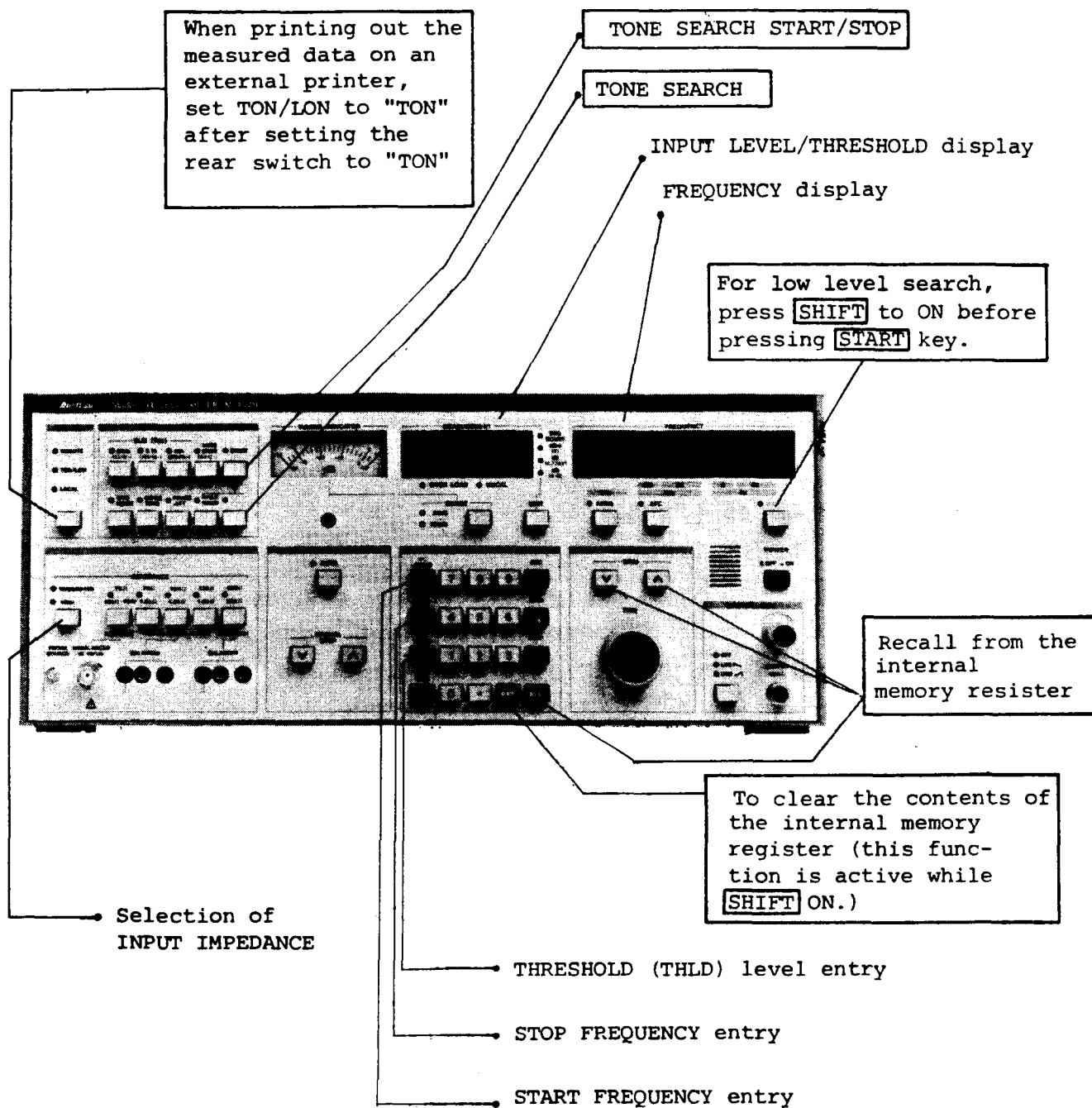

Tone Search

4.7.2 Basic Operation

(1) Basic operation

STEP	PROCEDURE
1	Press TONE SEARCH (ON).
2	Press START FREQ , STOP FREQ , or THLD as appropriate.
3	Enter the digits and decimal point as required.
4	Press Hz , kHz , or MHz as appropriate. +dB , -dB
5	Set STATUS to "TON" as required.
6	Press SHIFT (ON) for low level operation.
7	Press START (ON).

(2) Recall from the memory register

STEP	PROCEDURE
1	Press TONE SEARCH (ON).
2	Press RECALL .
3	Press frequency step ↓ or ↑ as appropriate.

This recall mode is reset by another operation, such as by pressing **Hz** , **kHz** , or **MHz** keys.

+dB **-dB**

Note: " **END** ... " is displayed when no data remains in the memory registers.

(3) Clearing of the memory register

STEP	PROCEDURE
1	Press TONE SEARCH (ON).
2	Press SHIFT (ON).
3	Press MEMORY .

(4) External printer connection and ADDRESS switch

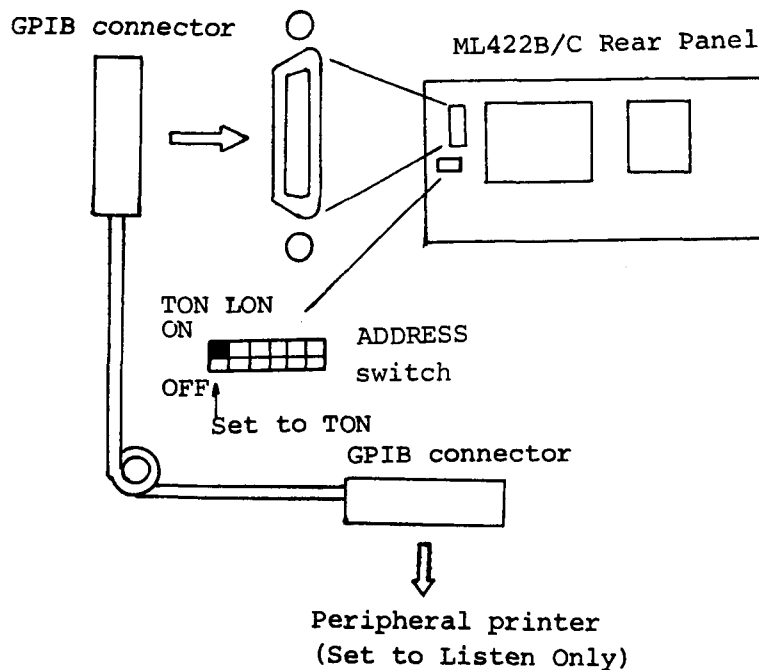

Modification of Input Impedance

4.8 Modification of Input Impedance

The ML422B/C has five input impedances and a high impedance for each of these impedances. However, a different impedance, for example, 50Ω , may be necessary depending on the application. In this case, the input impedance can be changed from 75Ω to 50Ω by adding a 150Ω resistor in parallel with the 75Ω input terminal. Since the input display is only about 1.78 dB LOW in this case, compensation is necessary. To increase the input impedance, set the input impedance to HIGH and connect the specified resistor to the input terminal. For example, for 900Ω BALANCED, set the ML422B/C to 600Ω HIGH and connect a 900Ω resistor to the input connector.

Example:

(1) 75Ω to 50Ω

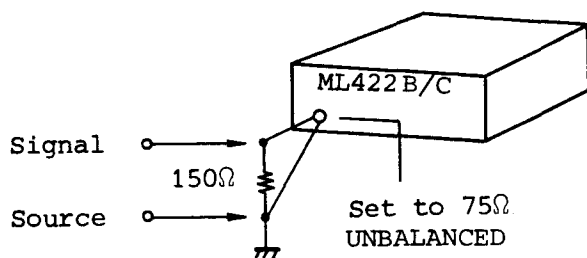

(2) 600Ω HIGH to 900Ω

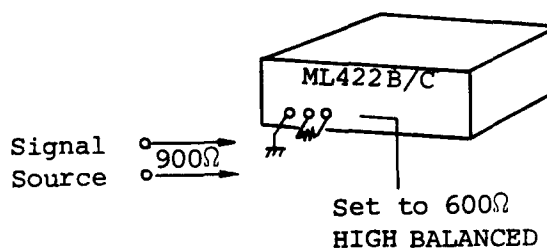

SECTION 5
PERFORMANCE CHECK

5.1 Introduction

This section deals with the procedures for conducting the performance check, carried out in order to confirm that the instrument meets the specifications. It is recommended that the performance check be conducted at a minimum of once a year, to ensure accuracy of measurement over a long term.

The performance check is also recommended after repairs have been carried out. In such a case, recalibration is sometimes required. This subject is dealt with in Section 3 in the Maintenance Manual.

Prior to the performance check, warm-up should be performed for both the ML422B/C and the measuring instruments being used.

The warm-up period required for the ML422B/C is a minimum of 30 minutes.

Except for the impedance tests, all of the performance check procedures described in this Section are conducted using 75 Ω unbalanced impedance.

The following Table shows the measuring instruments and devices required for calibration and adjustment of the instrument.

Introduction

INSTRUMENTS REQUIRED FOR CALIBRATION AND ADJUSTMENT

NO.	INSTRUMENT REQUIRED AND RECOMMENDED MODEL	INSTRUMENT TYPE AND SPECIFICATIONS	REQUIRED FOR
1	FREQUENCY SYNTHESIZER ANRITSU MODEL MG443A/B (with OPT 02)	<ul style="list-style-type: none"> ○ FREQUENCY RANGE 10 Hz - 30 MHz ○ REFERENCE OSCILLATOR STABILITY $\pm 1.5 \times 10^{-8}$ ○ HARMONIC DISTORTION 40 dB OR MORE 	<ul style="list-style-type: none"> ○ FREQUENCY RANGE ○ LEVEL MEASURING RANGE ○ INPUT IMPEDANCE (CMMR MEASUREMENT) ○ BANDWIDTH AND SELECTIVITY ○ INTRINSIC DISTORTION ATTENUATION ○ IF REJECTION ○ PHASE JITTER ○ WEIGHTED NOISE AND NOTCH FILTER ○ IMPULSE NOISE ○ SIGNAL SEARCH ○ REMOTO CONTROL ○ DEMODULATOR
2	FREQUENCY SYNTHESIZER ANRITSU MODEL MG545K/M (with OPT 02)	<ul style="list-style-type: none"> ○ FREQUENCY RANGE 10 kHz - 500 MHz ○ REFERENCE OSCILLATOR STABILITY $\pm 1.5 \times 10^{-8}$ 	<ul style="list-style-type: none"> ○ REFERENCE FREQUENCY STABILITY ○ IF REJECTION ○ IMAGE REJECTION
3	ATTENUATOR ANRITSU MODEL MN510D	<ul style="list-style-type: none"> ○ FREQUENCY RANGE DC - 500 MHz ○ ATTENUATION ACCURACY ± 0.3 dB (DC - 100 MHz, 0 - 90 dB) 	<ul style="list-style-type: none"> ○ LEVEL MEASURING RANGE ○ PHASE JITTER

INSTRUMENTS REQUIRED FOR CALIBRATION AND ADJUSTMENT (Cont'd)

NO.	INSTRUMENT REQUIRED AND RECOMMENDED MODEL	INSTRUMENT TYPE AND SPECIFICATIONS	REQUIRED FOR
4	FREQUENCY SYNTHESIZER ANRITSU MODEL MG440A/C	<ul style="list-style-type: none"> ○ FREQUENCY RANGE 10Hz - 30 MHz ○ SSB PHASE NOISE -115 dBc/Hz (2 kHz OFFSET) 	<ul style="list-style-type: none"> ○ BANDWIDTH AND SELECTIVITY
5	STANDARD LEVEL METER ANRITSU MODEL ML423A	<ul style="list-style-type: none"> ○ FREQUENCY RANGE 10 Hz - 30 MHz ○ MEASUREMENT ACCURACY ±0.2 dB WITH TRACEABILITY DATA 	<ul style="list-style-type: none"> ○ LEVEL MEASURING ACCURACY
6	NETWORK ANALYZER ANRITSU MODEL MS420A	<ul style="list-style-type: none"> ○ FREQUENCY RANGE 10 Hz - 30 MHz ○ MEASUREMENT RANGE (0 - -100 dB) ○ MEASUREMENT ACCURACY ±0.15 dB (0 - 50 dB) 	<ul style="list-style-type: none"> ○ INPUT IMPEDANCE (RETURN LOSS MEASUREMENT)
7	REFLECTION BRIDGE ANRITSU MODEL MA312 MODEL MA412A MODEL MA27A	<ul style="list-style-type: none"> ○ FREQUENCY RANGE 2 kHz - 2 MHz 75 Ω, 124 Ω, 135 Ω, 150 Ω BAL ○ FREQUENCY RANGE 10 Hz - 30 MHz 75 Ω UNBAL ○ FREQUENCY RANGE 10 Hz - 250 kHz 600 Ω BAL 	<ul style="list-style-type: none"> ○ INPUT IMPEDANCE (RETURN LOSS MEASUREMENT)

Introduction

INSTRUMENT REQUIRED FOR CALIBRATION AND ADJUSTMENT (Cont'd)

NO.	INSTRUMENT REQUIRED AND RECOMMENDED MODEL	INSTRUMENT TYPE AND SPECIFICATIONS	REQUIRED FOR
8	IMPEDANCE ANALYZER HP MODEL 4192A	<ul style="list-style-type: none"> ○ FREQUENCY RANGE 50 Hz - 13 MHz 	<ul style="list-style-type: none"> ○ INPUT IMPEDANCE (INPUT CAPACITANCE AND INPUT RESISTANCE MEASUREMENT)
9	OSCILLATOR NATIONAL MODEL VP-7220C	<ul style="list-style-type: none"> ○ FREQUENCY RANGE 1 Hz - 99.9 kHz ○ DISTORTION RATIO 0.002% (50 Hz - 50 kHz) 	<ul style="list-style-type: none"> ○ INTRINSIC DISTORTION ATTENUATION
10	LOW PASS FILTER ANRITSU MODEL M-238C	<ul style="list-style-type: none"> ○ FREQUENCY RANGE 50 MHz - 18.1 MHz ○ EFFECTIVE ATTENUATION 40 dB or more at $\sqrt{2} f_c - 3 f_c$ 	
11	SELECTIVE LEVEL METER ANRITSU MODEL ML422B/C	<ul style="list-style-type: none"> ○ FREQUENCY RANGE 50 Hz - 30 MHz 	<ul style="list-style-type: none"> ○ IF REJECTION ○ DEMODULATOR ○ TRACING OUTPUT
12	ATTENUATOR ANRITSU MODEL MN31A	<ul style="list-style-type: none"> ○ FREQUENCY RANGE DC - 1 MHz ○ ATTENUATION ACCURACY ± 0.2 dB (DC - 500 kHz, 0 - 90 dB) 	<ul style="list-style-type: none"> ○ PHASE JITTER

INSTRUMENT REQUIRED FOR CALIBRATION AND ADJUSTMENT (Cont'd)

NO.	INSTRUMENT REQUIRED AND RECOMMENDED MODEL	INSTRUMENT TYPE AND SPECIFICATIONS	REQUIRED FOR
13	PERSONAL COMPUTER ANRITSU MODEL PACKET II	○ GP-IB	○ REMOTE CONTROL
14	MULTIMETER YEW MODEL 2807	○ DC VOLTMETER ACCURACY $\pm 0.5\%$ OF RDG ± 2 DIGITS	○ OUTPUT FOR RECORDER
15	OSCILLOSCOPE NATIONAL MODEL VP-5415C	○ FREQUENCY RANGE DC - 50 MHz	○ EXTERNAL FREQUENCY REFERENCE INPUT
16	AC/DC METER YEW MODEL 2014	○ CURRENT RANGE 0 - 30 A ○ VOLTAGE RANGE 0 - 750 V	○ POWER CONSUMPTION

Introduction

INSTRUMENT REQUIRED FOR CALIBRATION AND ADJUSTMENT (Cont'd)

No.	DEVICE REQUIRED	TYPE AND SPECIFICATIONS	REQUIRED FOR
17	IMPEDANCE CONVERTER	UNBAL BAL ○ 75 Ω : 75 Ω (2 k - 2 MHz) ○ 75 Ω : 124 Ω (2 k - 2 MHz) ○ 75 Ω : 135 Ω (2 k - 2 MHz) ○ 75 Ω : 150 Ω (2 k - 2 MHz) ○ 75 Ω : 600 Ω (50 - 120 kHz) ALL ARE RETURN LOSS ≥30 dB	○ FREQUENCY RANGE ○ LEVEL MEASURING ACCURACY
18	HIGH POWER AMPLIFIER	FREQUENCY RANGE ADK-MK31516 50 Hz - 30 MHz AMPLIFIER APPROX. 30 dB MAX OUTPUT LEVEL ≥ 30 dBm	○ LEVEL MEASURING RANGE ○ LEVEL MEASURING ACCURACY

INSTRUMENT REQUIRED FOR CALIBRATION AND ADJUSTMENT (Cont'd)

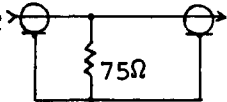
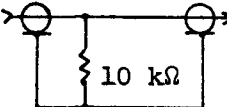
NO.	DEVICE REQUIRED	TYPE AND SPECIFICATIONS		REQUIRED FOR
19	STANDARD ATTENUATOR PAD WITH TRACE- ABILITY DATA	UNBAL 75 Ω 5 dB PAD 10 dB PAD 20 dB PAD 30 dB PAD	ANRITSU	o LEVEL MEASURING ACCURACY
20	THROUGH TYPE 75 Ω TERMINATOR	75 Ω TERMINATOR 	ANRITSU	o INPUT IMPEDANCE CMMR MEASUREMENT
21	POWER DIVIDER	75 Ω UNBAL DIVIDER (50 Hz - 30 MHz) 75 Ω BAL DIVIDER 124 Ω BAL DIVIDER 135 Ω BAL DIVIDER 150 Ω BAL DIVIDER (2 kHz - 2 MHz) 600 Ω BAL DIVIDER (50 Hz - 120 kHz)	ANRITSU	o PHASE JITTER o SIGNAL SEARCH
22	THROUGH TYPE 10 k Ω THERMINATOR	10 k Ω TERMINATOR 	ANRITSU	o OUTPUT FOR RECORDER

Reference Frequency Stability

5.2 Reference Frequency Stability

REFERENCE FREQUENCY stability is tested by sending a signal from a frequency synthesizer (stability 5×10^{-8} or more) to the ML422B/C and using the AFC function to check the REFERENCE FREQUENCY stability.

5.2.1 Specifications

- $\leq 5 \times 10^{-7} / 0 \text{ to } 45^{\circ}\text{C}$
- $\leq 1 \times 10^{-6} / \text{year}$ (aging rate)

5.2.2 Setup

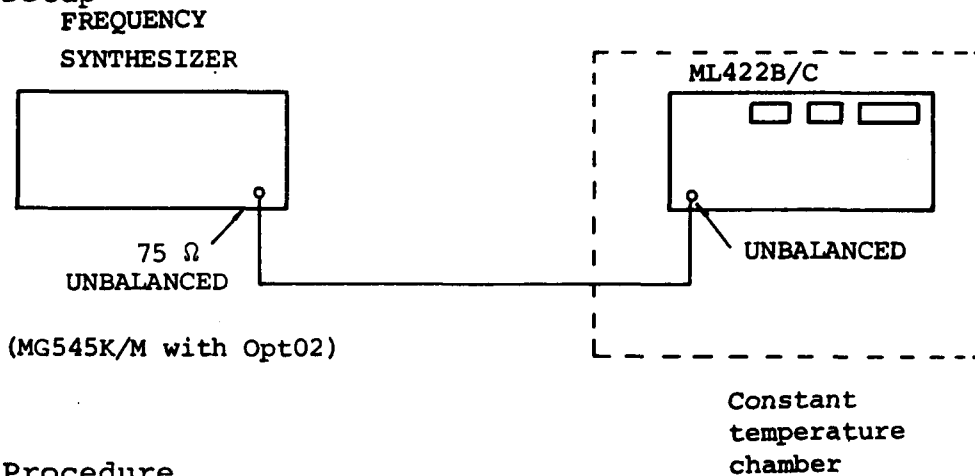

5.2.3 Procedure

- 1) Set the temperature chamber to 0°C , and wait until the temperature is fully stable. When the temperature is stabilized at 0°C , perform the following steps.
- 2) Connect the UNBALANCED output of the frequency synthesizer to the UNBALANCED terminal of the ML422B/C.
- 3) Set the frequency synthesizer output as follows:
 - o Output impedance 75 Ω UNBAL
 - o Output frequency 30.000000 MHz
 - o Output level 0 dBm

Note: Calibrate the frequency accuracy to 5×10^{-8} or better. The stability must be 5×10^{-8} or better.

Reference Frequency Stability

4) Set the ML422B/C as follows:

- o IMPEDANCE TERMINATED
- 75 Ω
10 kΩ 75 pF
- o SLM (BW) 3.1 k
- o FULL SCALE AUTO
- o UNIT dBm
- o FREQUENCY FREQ 3 0 MHz
-dB

5) Check that a 30 MHz signal (0 dBm) is received at the ML422B/C, then press the AFC key.

6) Read the FREQUENCY display.

7) Change the temperature of the constant temperature chamber to 45°C, and wait for the temperature of the ML422B/C to stabilize, then read the FREQUENCY display. Find the frequency stability from the below.

Frequency stability equation.

$$= \frac{(\text{Displayed value})45^{\circ}\text{C} - (\text{Standard value})0^{\circ}\text{C}}{(\text{Standard value})0^{\circ}\text{C}}$$

Notes:1 When changing the temperature using the constant temperature chamber, place only the ML422B/C in the chamber. If the frequency synthesizer is also placed in the chamber, the temperature characteristic of the frequency synthesizer will be added to the measured value, and high-accuracy measurement will be impossible.

2 For 1×10^{-6} /year stability, the test described above can be performed.

3 Before commencing this test, allow at least 60 minutes to elapse from the time at which the power is switched on.

Level Measuring Accuracy

5.3 Level Measuring Accuracy

The accuracy of level measurement is checked by measuring it at several frequencies.

A high degree of precision is required in these measurements. Therefore, use a STD attenuator PAD and STD level meter with data calibrated to a standard, and compensate the measured value with this calibrated data.

5.3.1 Specification

1) 75 Ω unbalanced

20 dB scale range , AFC (ON), SCALE (AUTO)

o SELECTIVE LEVEL METER

Temperature	23°C \pm 5°C	0°C to 45°C		
Frequency range	10 kHz to 13 MHz	50 Hz to 200 Hz	200 Hz to 13 MHz	13 MHz to 30 MHz
Level range 0 to +20 dBm	\pm 0.15 dB	\pm 0.2 dB	\pm 0.15 dB	\pm 0.2 dB
-80 to 0 dBm	\pm 0.1 dB			
-100 to -80 dBm	\pm 0.3 dB	\pm 1 dB	\pm 0.5 dB	\pm 0.5 dB
-110 to -100 dBm	\pm 1 dB	—	\pm 1.5 dB	\pm 1.5 dB

o WIDEBAND (Note: Warm up time 30 minu.)

Frequency range	200 Hz to 13 MHz	13 MHz to 30 MHz
Level range -50 to +20 dBm	\pm 0.3 dB	\pm 0.5 dB
-60 to -50 dBm	\pm 0.4 dB	\pm 0.6 dB

2) BALANCED

Add ± 0.1 dB to the above specifications

5.3.2 Setup

5.3.2.1 UNBALANCED measurement

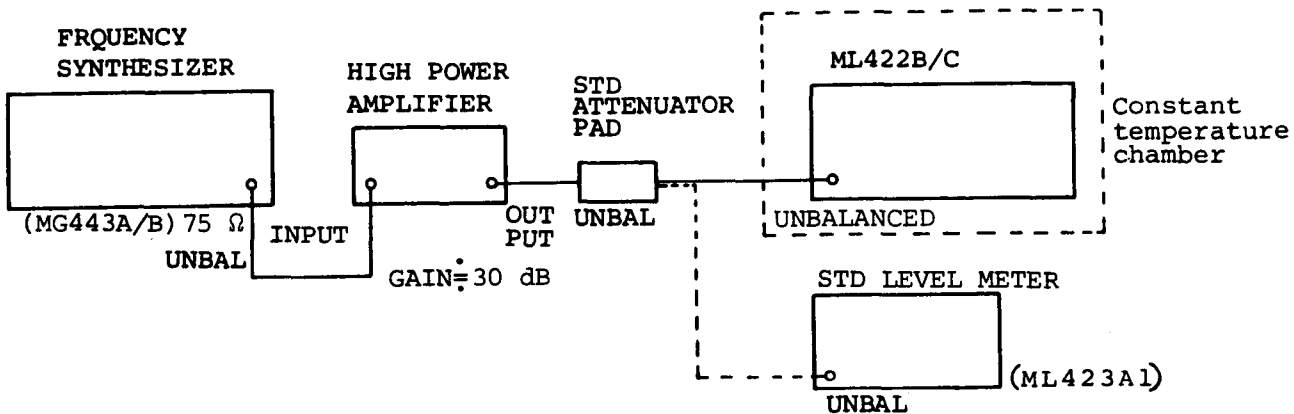

a) Setup for +20 to +10 dBm Measurement

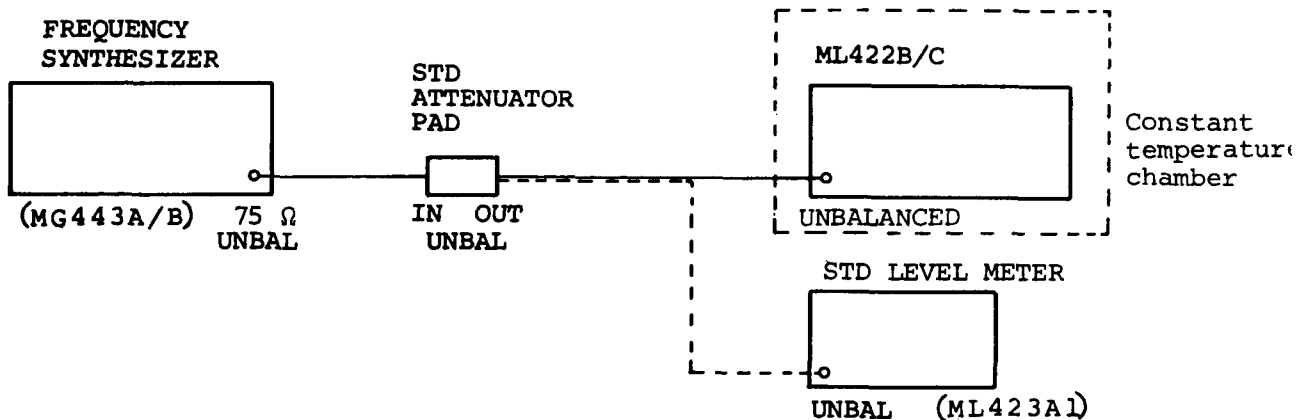

b) Setup for +10 to -100 dBm Measurement

Level Measuring Accuracy

5.3.2.2 BALANCED measurement

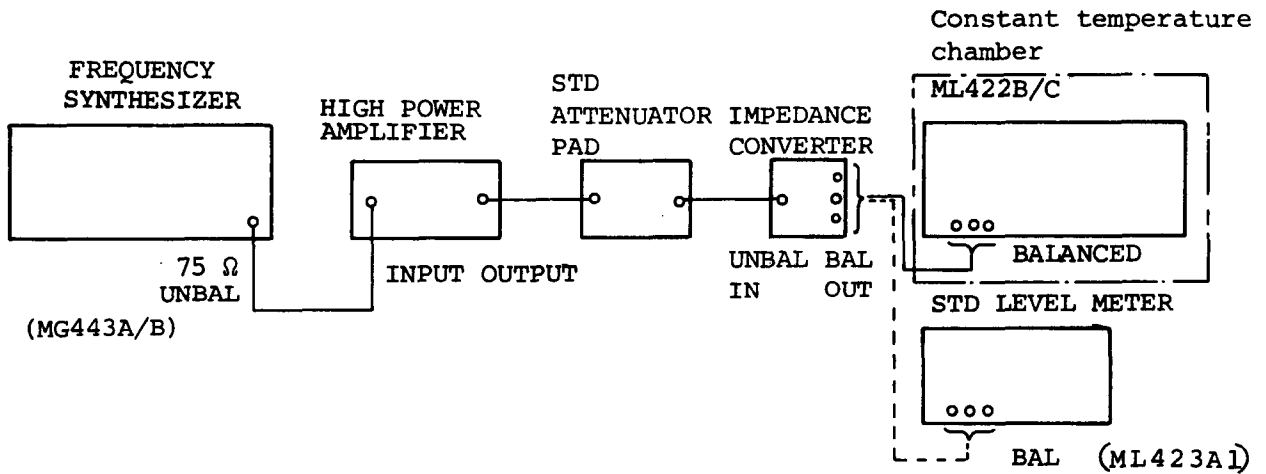

a) Setup for +20 to +10 dBm Measurement

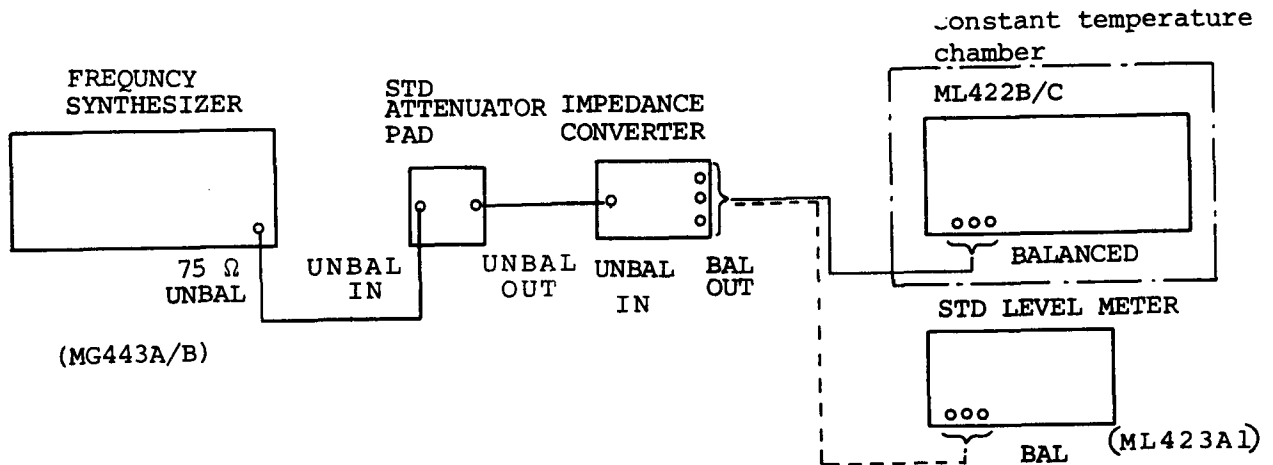

b) Setup for +10 to -100 dBm Measurement

5.3.3 Procedure

5.3.3.1 The temperature of the constant temperature chamber should be $23^{\circ}\text{C} \pm 5^{\circ}\text{C}$. If the room temperature is $23^{\circ}\text{C} \pm 5^{\circ}\text{C}$, the test can be performed without using a constant temperature chamber.

5.3.3.1.1 UNBALANCED measurement

- 1) Connect the frequency synthesizer output to the INPUT terminal of the STD LEVEL METER through the HIGH POWER AMPLIFIER (gain 30 dB , output level \geq +30 dBm) and STD ATTENUATOR PAD (UNBAL), as shown in par. 5.3.2.1. a).

When the measurement level is +10 dBm or less, connect the SYNTHESIZER output directly to the INPUT terminal; omitting the HIGH POWER AMP. (See par. 5.3.2.1. b).

- 2) Set the FREQUENCY SYNTHESIZER output as follows:

- o Output impedance 75 Ω UNBAL
- o Output frequency 50 Hz
- o Output level 0 dBm

- 3) Calibrate the output level as follows

- a) +20 to +10 dBm measurement

Use a 30 dB STD ATTENUATOR PAD and adjust the SYNTHESIZER output to obtain a STD LEVEL METER input level of 0 dBm

- b) +10 to -100 dBm measurement

Connect the SYNTHESIZER output directly to the STD LEVEL METER INPUT terminal and adjust the output to obtain an input level of 0 dBm on the STD LEVEL METER.

Level Measuring Accuracy

- 4) Set the ML422B/C as follows:
- o IMPEDANCE 75 Ω
 - o SLM (BW) 10 k Ω 75 pF
 - o FULL SCALE
 - o RANGE
 - o AFC
 - o UNIT
 - o FREQUENCY

5) Input the calibrated output of step 3) to the ML422B/C UNBALANCED terminal.

6) Vary the attenuation of the STD ATTENUATOR PAD as shown in the Table below, and measure the levels from +20 to -100 dBm in 10 dB steps. Read the MEASUREMENT display at each step.

Value of STD ATTENUATOR PAD inserted for each measurement level

Measurement level	Inserted STD ATTENUATOR PAD value
+20 dBm	10 dB
+10 dBm	20 dB
- 0 dBm	0 dB
-10 dBm	10 dB
-20 dBm	20 dB
-30 dBm	30 dB
-40 dBm	40 dB
-50 dBm	50 dB
-60 dBm	60 dB
-70 dBm	70 dB
-80 dBm	80 dB
-90 dBm	90 dB
-100 dBm	100 dB
-110 dBm	110 dB

Level Measuring Accuracy

7) Change FREQUENCY and MEASUREMENT MODE of the FREQUENCY SYNTHESIZER and ML422B/C as shown in the Table below, and repeat steps 3), 5), and 6). Set the MEASUREMENT MODE and FREQUENCY of step 4) as shown in the Table below.

The measurement level range for each MEASUREMENT MODE is:

20 Hz	-110 to +20 dBm
		-100 to +20 dBm
		(f < 200 Hz)
3.1 k	-100 to +20 dBm
48 k	-80 to +20 dBm
WIDEBAND	-60 to +20 dBm

Level Measuring Accuracy

	MEASUREMENT MODE	FREQUENCY setting	
		SYNTHESIZER	ML422B/C setting
1	20 Hz	200 Hz	FREQ 2 0 0 Hz
2	WIDEBAND	Same as above	Arbitrary
3	20 Hz	10 kHz	FREQ 1 0 kHz +dB
4	3.1 k	Same as above	Arbitrary
5	48 k	36 kHz	FREQ 3 6 kHz +dB
6	20 Hz	13 MHz	FREQ 1 3 MHz -dB
7	3.1 k	Same as above	Same as above
8	48 k	Same as above	Same as above
9	WIDEBAND	Same as above	Arbitrary
10	20 Hz	30 MHz	FREQ 3 0 MHz -dB
11	3.1 k	Same as above	Same as above
12	48 k	Same as above	Same as above
13	WIDEBAND	Same as above	Arbitrary

Note: When making measurements in the order shown above, omit the calibrations indicated shown in steps 3) and 5) for the steps in which "Same as above" is shown in the SYNTHESIZER column.

5.3.3.1.2 BALANCED measurement

The impedances of BALANCED measured here are 75 Ω BAL, 124 Ω BAL, 135 Ω BAL, 150 Ω BAL, and 600 Ω BAL.

Use an IMPEDANCE CONVERTER, STD ATTENUATOR PAD, and STD LEVEL METER matched to the impedance to be measured.

- 1) Connect the FREQUENCY SYNTHESIZER output to the INPUT terminal of the STD LEVEL METER through the HIGH POWER AMPLIFIER (gain 30 dB, output level $\geq +30$ dBm), IMPEDANCE CONVERTER (75 Ω BAL), and STD ATTENUATOR (75 Ω BAL) as shown in par. 5.3.2.2 a).

When the measurement level is +10 dBm or less, connect the FREQUENCY SYNTHESIZER output directly to the INPUT terminal of the IMPEDANCE CONVERTER (75 Ω BAL), instead of through the HIGH POWER AMPLIFIER. (See par. 5.3.2.1 b))

- 2) Set the FREQUENCY SYNTHESIZER output as follows:
 - o Output impedance 75 Ω UNBAL
 - o Output frequency 2 kHz
 - o Output level approx. 5 dBm

- 3) Calibrate the output level as follows:
 - a) +20 to +10 dBm measurement
Using a 25 dB STD ATTENUATOR PAD, adjust the FREQUENCY SYNTHESIZER output to obtain an STD LEVEL METER input level of +5 dBm.

Level Measuring Accuracy

- b) +10 to -110 dBm measurement

Adjust the Frequency Synthesizer output to obtain an input level of +5 dBm on the STD level meter.

- 4) Set the ML422B/C as follows:

o IMPEDANCE

o SLM (BW)
o FULL SCALE
o RANGE
o AFC
o UNIT
o FREQUENCY

- 5) Connect the calibrated output of step 3) to the BALANCED terminal of the ML422B/C.

- 6) Vary the attenuation of the STD attenuator pad as shown in Table in par. 5.3.3.1.1,6) and measure the +20 to -110 dBm measurement level in 10 dB steps, reading the MEASUREMENT display at each step.

- 7) Set the SYNTHESIZER MODE and FREQUENCY of the synthesizer as shown in the Table below. The measurement level range at each MEASUREMENT MODE is:

<input type="text" value="20 Hz"/>	-110 to +20 dBm
<input type="text" value="3.1 k"/>	-100 to +20 dBm

48 k -80 to +20 dBm
WIDEBAND -60 to +20 dBm

	MEASUREMENT MODE	FREQUENCY setting	
		SYNTHESIZER	ML422B/C
1	WIDEBAND	2 kHz	Same as step 4)
2	20 Hz	10 kHz	FREQ 1 0 kHz +dB
3	3.1 k	Same as above	
4	20 Hz	2 MHz	FREQ 2 MHz -dB
5	3.1 k	Same as above	Same as above
6	48 k	Same as above	Same as above
7	WIDEBAND	Same as above	Arbitrary

* When making measurements in the order above, omit the calibration indicated in step 5) for the steps with "Same as above" shown in the SYNTHESIZER column.

8) Perform of 124 Ω BAL measurement (ML422B)

Change the IMPEDANCE CONVERTER, STD ATTENUATOR PAD, and STD LEVEL METER to a 124 Ω BAL system.

Change the ML422B IMPEDANCE setting to

TERMINATED **124 Ω**
1.5 kΩ and repeat steps 2) through 7). Change the IMPEDANCE setting of step 4) to **TERMINATED** **124 Ω**
1.5 kΩ.

Level Measuring Accuracy

- 9) Perform of 150 Ω BAL measurement (ML422C)

Change the IMPEDANCE CONVERTER, PAD, and STD LEVEL METER to a 150 Ω BAL system. Change the ML422C IMPEDANCE setting to

TERMINATED

150 Ω
1.5 k Ω

 and repeat steps 2) through 7).

Change the IMPEDANCE setting of step 4) to

TERMINATED

150 Ω
1.5 k Ω

 .

- 10) Perform of 600 Ω BAL measurement

Change the IMPEDANCE CONVERTER, PAD, and STD LEVEL METER to a 600 Ω BAL system.

- a) Set the SYNTHESIZER output as follows:

- o Output impedance 75 Ω UNBAL
- o Output frequency 200 Hz
- o Output level approx. 5 dBm

- b) Calibrate the output level as described in step 3) and perform step 5).

- c) Set the ML422B/C IMPEDANCE and FREQUENCY at the settings of step 4), except as follows, and repeat step 4):

- o IMPEDANCE

TERMINATED

600 Ω
20 k Ω

- o FREQUENCY

2

0

0

 . Hz

- d) Repeat steps 5) and 6).

- e) Change the settings of step 7) as shown in the Table below, and repeat step 7).

Level Measuring Accuracy

	MEASUREMENT MODE	FREQUENCY setting	
		SYNTHESIZER	ML422B/C
1	20 Hz	200 Hz	FREQ 2 0 0 Hz
2	WIDEBAND	Same as above	Arbitrary
3	20 Hz	10 kHz	FREQ 1 0 kHz +dB
4	3.1 k	Same as above	Same as above
5	48 k	36 kHz	FREQ 3 6 kHz +dB
6	20 Hz	120 kHz	FREQ 1 2 0 kHz +dB
7	3.1 k	Same as above	Same as above
8	48 k	Same as above	Same as above
9	WIDEBAND	Same as above	Arbitrary

Level Measuring Accuracy

Note: When making measurements in the order above, skip the calibration of step 6) at the steps with "Same as above" in the SYNTHESIZER column.

This ends testing of the 23°C ±5° LEVEL MEASUREMENT ACCURACY. Next, test the 0°C and 45°C LEVEL MEASUREMENT ACCURACY.

5.3.3.2 0°C test

Set the constant temperature chamber temperature to 0°C.

Repeat the tests described in par. 5.3.3.1.

*1 Allow at least 60 minutes to elapse after the ML422B/C ambient temperature has reached 0°C before beginning the tests.

*2 When changing the temperature using the constant temperature chamber, place only the ML422B/C in the chamber. If the SYNTHESIZER and other equipment are placed in the chamber, the temperature characteristics of the synthesizer and other equipment will be added to the measured value and accurate measurement will be impossible.

5.3.3.3 45°C test

Set the temperature of the constant temperature chamber to 45°C.

Repeat the tests described in par. 5.3.3.1.

*1 Allow at least 60 minutes to elapse after the ML422B/C ambient temperature has reached 45°C before beginning the tests.

5.3.3.4 Compensation

In this measurement the measured value is compensated using data obtained with the STD ATTENUATOR PAD and STD LEVEL METER. The true measurement is calculated by means of the following formula:

$$\text{True measurement} = (\text{measured value}) - (\text{compensation value})$$

Input Impedance

5.4 Input Impedance

There are three kinds of INPUT IMPEDANCE measurement; input capacitance and resistance measurement, RETURN LOSS measurement, and CMRR measurement.

5.4.1 Specifications

(1) UNBALANCED input (75Ω)

TERMINATED: Return loss ≥ 35 dB (50 Hz to 20 MHz)
 ≥ 25 dB (20 MHz to 30 MHz)

HIGH: $10 \text{ k}\Omega \pm 10\%$ paralleled by ≤ 80 pF

(2) BALANCED input

TERMINATED: Return loss ≥ 30 dB
CMRR ≥ 30 dB

HIGH: 75Ω , 124Ω , 135Ω , 150Ω : Typically $2 \text{ k}\Omega$ at 2 MHz
 600Ω : Typically $15 \text{ k}\Omega$ at 120 kHz

5.4.2 Setup

5.4.2.1 Return loss measurement

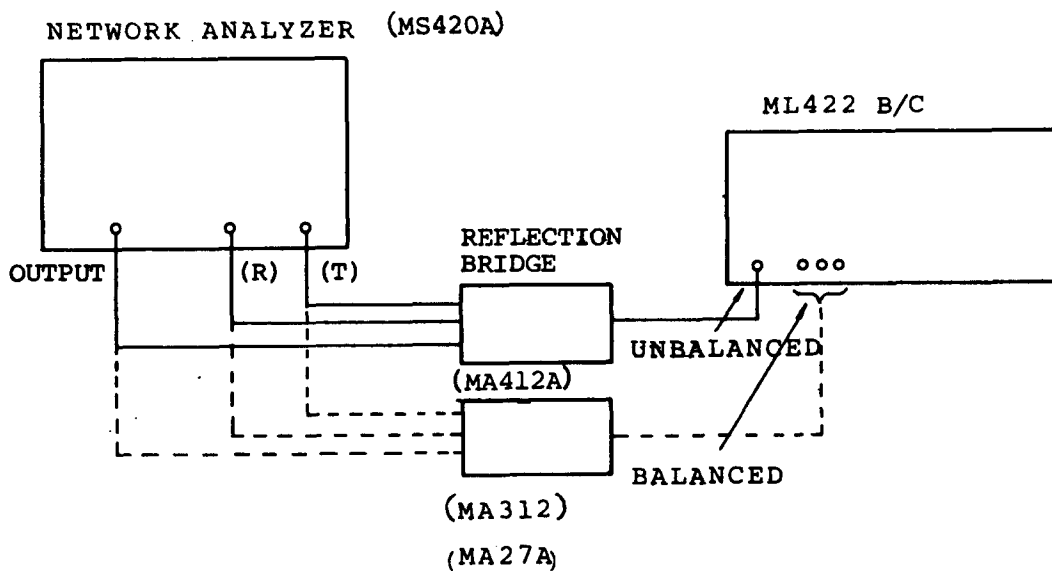
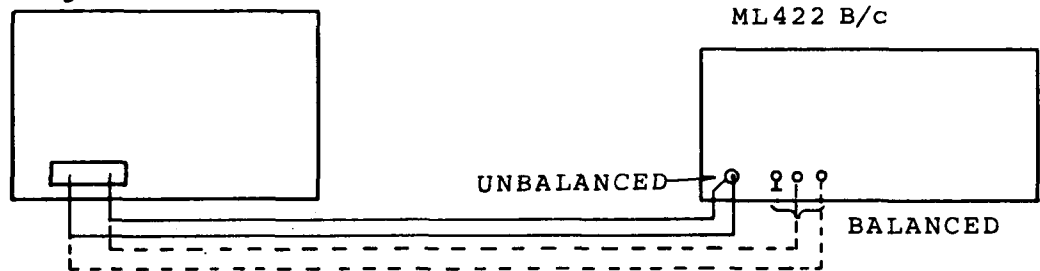
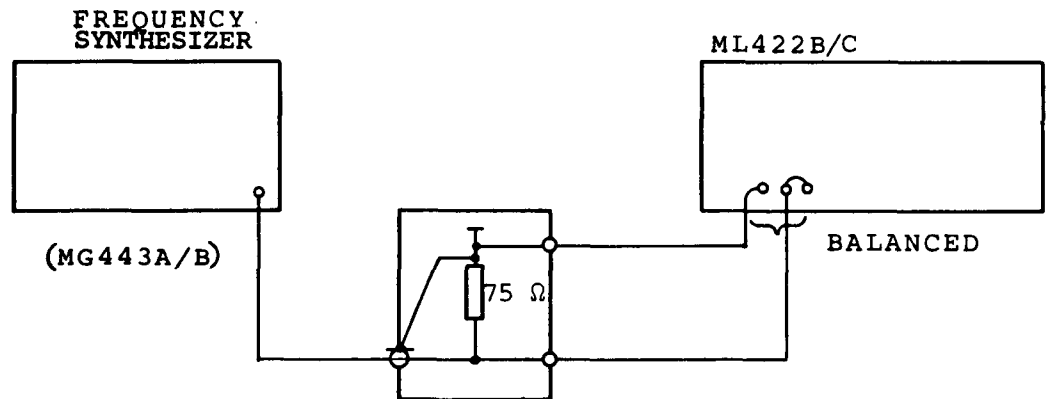

Fig. 5.4

5.4.2.2 Input capacitance, input resistance, and input impedance measurement when the input impedance is high. RLC METER



5.4.2.3 CMRR measurement



5.4.3 Procedure

5.4.3.1 Return loss measurement

5.4.3.1.1 UNBALANCED measurement

- 1) Connect the OUTPUT and INPUT (R), (T), terminals of the network analyzer to the INPUT and OUTPUT (R), (T), terminals of the reflection bridge. Then connect the UNBALANCED TEST terminal to the UNBALANCED terminal of the ML422B/C.

- 2) Set the network analyzer as follows:

START FREQ 50 Hz
 STOP FREQ 30 MHz
 OUTPUT LEVEL 0 dBm

Input Impedance

- 3) Set the ML422B/C as follows:

IMPEDANCE TERMINATED

75 Ω
10 k Ω 75 pF

- 4) Sweep the network analyzer and read the highest value for RETURN LOSS.

Note: Calibrate the network analyzer and reflection bridge before making this measurement.

5.4.3.1.2 BALANCED measurement

- 1) Connect the OUTPUT and INPUT (R), (T), terminals of the network analyzer to the INPUT and OUTPUT (R), (T), terminals of the reflection bridge. Then connect the TEST terminal to the BALANCED terminal of the ML422B/C. Since the reflection bridge differs according to the impedance, use a reflection bridge matched to the impedance.
- 2) Set the network analyzer START and STOP FREQUENCY according to the MEASUREMENT IMPEDANCE as follows:

The OUTPUT LEVEL may be 0 dBm in all cases.

75 Ω , 124 Ω , 135 Ω , 150 Ω Balanced measurement

START FREQ 2 kHz

STOP FREQ 2 MHz

600 Ω Balanced measurement

START FREQ 50 Hz

STOP FREQ 120 kHz

3) Set the ML422B/C according to the measurement impedance as follows:

a) 75 Ω Balanced measurement

IMPEDANCE TERMINATED

75 Ω
1.5 k Ω

b) 124 Ω Balanced measurement

IMPEDANCE TERMINATED

124 Ω
1.5 k Ω

c) 135 Ω Balanced measurement

IMPEDANCE TERMINATED

135 Ω
1.5 k Ω

d) 150 Ω Balanced measurement

IMPEDANCE TERMINATED

150 Ω
1.5 k Ω

e) 600 Ω Balanced measurement

IMPEDANCE TERMINATED

600 Ω
20 k Ω

4) Sweep the network analyzer at each measurement impedance and read the highest value of return loss obtained.

Note: Calibrate the network analyzer and reflection bridge before marking this measurement.

5.4.3.2 Input capacitance and resistance measurement (75 Ω unbalanced).

Input Impedance

5.4.3.2.1 Input capacitance measurement

- 1) Connect the HIGH and LOW terminals of the RLC meter to the center conductor and ground end of the UNBALANCED terminal of the ML422B/C.
- 2) Set the RLC meter as follows:
Measurement frequency 1 MHz
Measurement item C measurement
- 3) Set the ML422B/C as follows:
IMPEDANCE HIGH

75 Ω
10 k Ω 75 pF
- 4) Read the capacitance value from the RLC meter.

5.4.3.2.2 Input resistance measurement

- 1) Connect the HIGH and LOW terminals of the RLC meter to the center conductor and ground end of the UNBALANCED terminal of the ML422B/C.
- 2) Set the RLC meter as follows:
Measurement frequency 10 kHz
Measurement item R measurement
- 3) Set the ML422B/C according to the measurement impedance as follows:
IMPEDANCE HIGH

75 Ω
10 k Ω 75 pF
- 4) Read the resistance value of the measurement frequency from the RLC meter.

5.4.3.2.3 Input impedance measurement when the impedance is high (75 Ω , 124 Ω , 135 Ω , 150 Ω , 600 Ω Balanced).

1) Connect the HIGH and LOW terminals of the RLC meter to the BALANCED terminals of the ML422B/C. (Do not connect to the ground terminal.)

2) Set the RLC meter as follows:

Measurement frequency

75 Ω , 124 Ω , 135 Ω , 150 Ω Balanced .. 200 kHz

600 Ω Balanced 20 kHz

Measurement item $|\dot{Z}|$ measurement

3) Set the ML422B/C impedance according to the measurement impedance as follows:

a) 75 Ω Balanced measurement ... HIGH
 75 Ω
 1.5 k Ω

b) 124 Ω Balanced measurement HIGH
 124 Ω
 1.5 k Ω

c) 135 Ω Balanced measurement HIGH
 135 Ω
 1.5 k Ω

d) 150 Ω Balanced measurement HIGH
 150 Ω
 1.5 k Ω

e) 600 Ω Balanced measurement HIGH
 600 Ω
 20 k Ω

4) Read the measured value from the RLC meter at each impedance measurement.

Input Impedance

5.4.3.2.4 CMRR measurement

- 1) Make the connections to the ML422B/C BALANCED input terminal as shown in Fig. 5.4.2.3 (Do not connect to the ground terminal).
- 2) Connect the synthesizer output terminal to one of the ML422B/C BALANCED terminals straight through the 75 Ω feedthrough terminator and connect the other side of the ground terminal to the ML422B/C ground terminal.

* 75 Ω Balanced measurement *

- 3) Set the synthesizer as follows:
 - o Output impedance 75 Ω UNBAL
 - o Output level 0 dBm
 - o Output frequency 2 kHz
- 4) Set the ML422B/C as follows:
 - o IMPEDANCE

75 Ω
1.5 k Ω
 - o MEASUREMENT MODE

WIDEBAND

 - o FULL SCALE

AUTO

 - o RANGE

100 dB

 - o UNIT

dBm

- 5) Send the synthesizer signal to the ML422B/C and read the MEASUREMENT display.

Find the CMRR from,

$$\text{CMRR} = (\text{synthesizer output level}) - (\text{ML422B/C receiving level})$$

If the synthesizer output level is 0 dBm at this measurement, the reading of absolute level value of the ML422B/C is the CMRR.

- 6) Change the synthesizer frequency to 10 kHz, 2 MHz, and repeat step 5).

* 124 Ω Balanced measurement *

- 7) Change the ML422B impedance as follows:

IMPEDANCE

TERMINATED

124 Ω
1.5 kΩ

and repeat steps 3) and 6).

$$\text{CMRR} = (\text{Synthesizer output level}) - (\text{Received level of ML422B}) + (2 \text{ dB})$$

* 135 Ω Balanced measurement *

- 8) Change the ML422B/C impedance as follows:

IMPEDANCE

TERMINATED

135 Ω
1.5 kΩ

and repeat step 3), 5) and 6).

$$\text{CMRR} = (\text{Synthesizer output level}) - (\text{Received level of ML422B/C}) + (2.5 \text{ dB})$$

* 150 Ω Balanced measurement *

- 9) Change the ML422C impedance as follows:

IMPEDANCE

TERMINATED

150 Ω
1.5 kΩ

and repeat steps 3) and 6).

$$\text{CMRR} = (\text{Synthesizer output level}) - (\text{Received level of ML422C}) + (3 \text{ dB})$$

Input Impedance

* 600 Ω Balanced measurement *

- 10) Change the ML422B/C impedance as follows:

IMPEDANCE TERMINATED

600 Ω

20 k Ω

- 11) Change the synthesizer frequency to 50 Hz, and repeat step 5).

$$\text{CMRR} = (\text{Synthesizer output level}) - (\text{Received level ML422B/C}) + (9 \text{ dB})$$

- 12) Change the synthesizer frequency to 200 Hz, 1 kHz, 3.4 kHz, and 120 kHz, and repeat step 5).

5.5 Bandwidth and Selectivity

The PASS BANDWIDTH and ATTENUATION CHARACTERISTIC are measured.

5.5.1 Specifications

Bandwidth	Pass bandwidth	Attenuation characteristic
20 Hz	$\geq 6\text{ Hz}$ (0.5 dB) $16\text{ Hz} \pm 20\%$ (3 dB)	Within $\pm 35\text{ Hz}$ (45 dB) Within $\pm 70\text{ Hz}$ (60 dB) Within $\pm 2\text{ kHz}$ (80 dB)
3.1 kHz	$\geq 1\text{ kHz}$ (0.5 dB) $3.1\text{ kHz} \pm 10\%$ (3 dB)	Within $\pm 1.85\text{ kHz}$ (60 dB) Within $\pm 2.4\text{ kHz}$ (70 dB)
48 kHz	$\geq 30\text{ kHz}$ (0.7 dB) $48\text{ kHz} \pm 10\%$ (3 dB)	Within $\pm 36\text{ kHz}$ (60 dB)

5.5.2 Setup



5.5.3 Procedure

- 1) Connect the synthesizer output to the UNBALANCED terminal of the ML422B/C.

Bandwidth and Selectivity

2) Set the synthesizer as follows:

- o Output impedance 75 Ω UNBAL
- o Output frequency 1 MHz
- o Output level 0 dBm

3) Set the ML422B/C as follows:

- o IMPEDANCE TERMINATED
75 Ω
10 k Ω 75 pF
- o SLM (BW) 20 Hz
- o FULL SCALE AUTO
- o UNIT dB (X-R)
- o RANGE 20 dB
- o FREQUENCY FREQ 1 MHz
-dB

4) Check that the synthesizer output is being received at the ML422B/C, then set the ML422B/C AFC key to ON .

After the FREQUENCY is stabilized, set the AFC key to OFF.

5) Press the DATA ENTRY REF(R) , MEMORY keys. Check that the MEASUREMENT display indicates 0.00 dB.

* PASS BANDWIDTH measurement *

6) Lower the synthesizer frequency from 1 MHz to obtain an ML422B/C MEASUREMENT display reading of -0.50 dB. Read the synthesizer frequency at this time. If the ML422B/C MEASUREMENT display does not indicate -0.50 dB, read the synthesizer frequency at the plus side nearest to the level of -0.50 dB.

- 7) Increase the frequency of the frequency synthesizer from 1 MHz to obtain an ML422B/C MEASUREMENT display reading of -0.50 dB. Read the synthesizer frequency at this time. If the ML422B/C MEASUREMENT display does not indicate -0.50 dB, read the synthesizer frequency at the minus side nearest to the level of -0.50 dB.
- 8) Subtract the reading of step 6) from the reading of step 7). This is the 0.5 dB passband width.
- 9) To obtain the value -3.00 dB on the MEASUREMENT display, repeat step 6).
- 10) To obtain the value -3.00 dB on the MEASUREMENT display, repeat step 7).
- 11) Subtract the reading of step 9) from the reading of step 10). This is the 3 dB passband width.
- 12) Change the ML422B/C settings indicated in step 3) as shown below:

MEASUREMENT MODE SLM (BW) 3.1 k
and repeat steps 5) through 11).
- 13) Change the ML422B/C settings indicated in step 3) as shown below:

MEASUREMENT MODE SLM (BW) 48 k
and repeat steps 5) through 11).
- * ATTENUATION CHARACTERISTIC measurement
- 14) Reset the synthesizer frequency to 1 MHz, and change the RANGE setting of step 3) to 100 dB.
- 15) Press the DATA ENTRY REF (R) , MEMORY keys. Check that the MEASUREMENT display indicates 0.0 dB.
- 16) To obtain the values -45 dB, -60 dB, and -80 dB, for each MEASUREMENT display, repeat steps 6) and 7).

Bandwidth and Selectivity

- 17) Subtract 1 MHz from the readings of step 16). This is the detuning frequency value (BW 20 Hz).
- 18) Change the ML422B/C setting as shown below:
MEASUREMENT MODE SLM (BW) 3.1 k
and repeat step 15).
- 19) To obtain the value -60 dB and -70 dB for each MEASUREMENT display, repeat steps 6) and 7).
- 20) Subtract 1 MHz from the readings of step 19).
This is the detuning frequency value (BW 3.1 kHz).
- 21) Change the ML422B/C settings as shown below:
MEASUREMENT MODE SLM (BW) 48 k
and repeat step 15).
- 22) To obtain the value -60 dB on the MEASUREMENT display, repeat steps 6) and 7).
- 23) Subtract 1 MHz from the readings of step 22).
This is the detuning frequency value (BW 48 kHz).

5.6 Intrinsic Distortion Attenuation

The intrinsic distortion attenuation is measured with a synthesizer having a harmonic distortion attenuation of 80 dB or greater. When the synthesizer does not have a harmonic distortion attenuation of 80 dB or greater, the second and third harmonics are increased to 80 dB or greater by means of a low-pass filter which suppresses the second and third harmonics of the measurement frequency.

5.6.1 Specifications

Input level below 10 dBm:

Single tone, 2nd and 3rd order respectively
 ≥ 70 dB (1 kHz to 12 MHz)

5.6.2 Setup

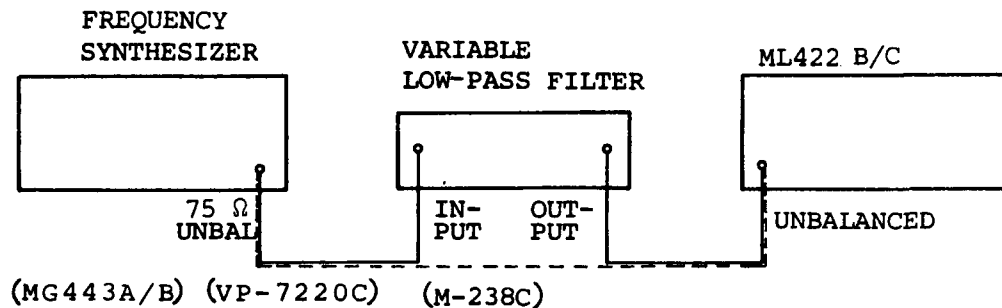

5.6.3 Procedures

- 1) Connect the synthesizer output to the UNBALANCED terminal of the ML422B/C through a low-pass filter. When a synthesizer having a harmonic distortion attenuation of 80 dB or greater is used, the low-pass filter is unnecessary.

Intrinsic Distortion Attenuation

- 2) Set the synthesizer as follows:
 - o Output impedance 75 Ω UNBAL
 - o Output frequency 1 kHz
 - o Output level + 10 dBm

- 3) Set the ML422B/C as follows:
 - o IMPEDANCE

TERMINATED
75 Ω
10 k Ω 75 pF

 - o SLM (BW)

20 Hz

 - o FULL SCALE

AUTO

 - o RANGE

100 dB

 - o UNIT

dBm

 - o FREQUENCY

FREQ	1	kHz
		+dB

- 4) Set the low-pass filter cut off frequency greater than the measurement frequency. By doing this, the second and third harmonics are suppressed by 80 dB or more.

- 5) Receive the output of the low-pass filter with the ML422B/C and adjust the synthesizer output to obtain a measured value of approximately 10 dBm .

- 6) Change the unit key dBm to dB(X-R), and press the DATA ENTRY

REF(R)

 ,

MEMORY

 keys and check that the ML422B/C display indicates 0.0 dB.

- 7) Set the ML422B/C FREQUENCY to double the synthesizer set frequency, and read the displayed value.

- 8) Set the ML422B/C FREQUENCY to triple the synthesizer set frequency and read the displayed value.

Note: When setting 2 MHz, omit step 8.

Intrinsic Distortion Attenuation

- 9) Set the synthesizer and ML422B/C frequencies to 10 kHz, 100 kHz, 1 MHz, 5 MHz, 10 MHz, and 12 MHz, and repeat steps 4) through 8) at each frequency.

Set the ML422B/C frequency as follows:

or

Note: When setting 123 kHz.

IF Rejection

5.7 IF Rejection

There are four IF frequencies; 56.6 MHz, 600 kHz, 40 kHz (SLM (BW) 48 kHz) and 25 kHz (SLM (BW) 20 Hz, 3.1 kHz). These frequencies are input to the ML422B/C and the rejection ratio is measured.

5.7.1 Specifications

≥70 dB (56.6 MHz; refer to full scale value)
≥80 dB (other frequencies)

5.7.2 Setup

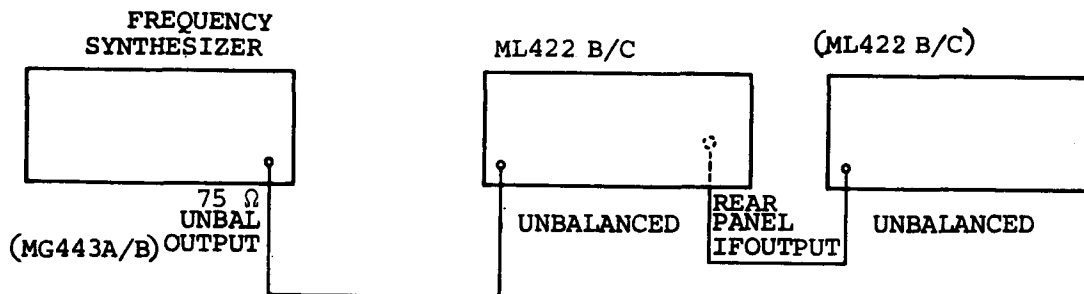

5.7.3 Procedure

- 1) Connect the output of the synthesizer to the UNBALANCED terminal of the ML422B/C.
- 2) Set the synthesizer as follows:
 - o Output impedance 75 Ω UNBAL
 - o Output frequency 110 kHz
 - o Output level 0 dBm

3) Set the ML422B/C as follows:

- o IMPEDANCE TERMINATED
75 Ω
10 k Ω 75 pF
- o SLM (BW) 20 Hz
- o FULL SCALE AUTO off
FULL SCALE 0 MHz
-dB
- o RANGE 100 dB
- o UNIT dBm
- o FREQUENCY FREQ 1 1 0 kHz
+dB

4) Send the synthesizer output to the ML422B/C and check that the ML422B/C MEASUREMENT display indicates 0 dBm.

* 56.6 MHz *

5) Set the synthesizer frequency to 56.6 MHz and read the ML422B/C MEASUREMENT display.

This is the IF rejection value for 56.6 MHz.

* 600 kHz, 25 kHz *

6) Set the synthesizer frequency to 600 kHz and 25 kHz and read the ML422B/C MEASUREMENT display at each frequency. These are the IF rejection values for 600 kHz and 25 kHz.

* 40 kHz (SLM (BW) 48k) *

7) Connect the IF OUTPUT terminal of the ML422B/C to the UNBALANCED terminal of the measuring ML422B/C.

IF Rejection

- 8) Set the measuring ML422B/C as follows:
- o IMPEDANCE

TERMINATED
75 Ω
10 k Ω 75 pF
 - o SLM (BW)

20 Hz

 - o FULL SCALE

AUTO

 - o UNIT

dBm

 - o RANGE

100 dB

 - o FREQUENCY

FREQ	4	0	kHz
			+dB
- 9) Set the synthesizer as described in step 2).
- 10) Change the ML422B/C SLM (BW) setting to

48 kHz

 and set the ML422B/C as described in step 3).
- 11) Perform step 4).
- 12) Receive the output of the IF OUTPUT on the ML422B/C with the measuring ML422B/C and read the MEASUREMENT display.
- 13) Change the synthesizer output frequency to 40 kHz, and read the MEASUREMENT value displayed on the measuring ML422B/C.
- 14) Subtract the reading of step 13) from the reading of step 12). This is the 40 kHz IF rejection value.

5.8 Image Rejection

The image rejection for IF frequencies of 56.6 MHz, 600 kHz, 40 kHz, and 25 kHz is measured.

The measurement frequency and image frequency have the following relationship:

$$f_{IM} = f \pm 2 \times f_{IF}$$

IMAGE FREQUENCY MEASURED FREQUENCY IF FREQUENCY
 (+: BW 20 Hz, BW 3.1 kHz, -: BW 48 kHz)

5.8.1 Specifications

≥80 dB

5.8.2 Setup

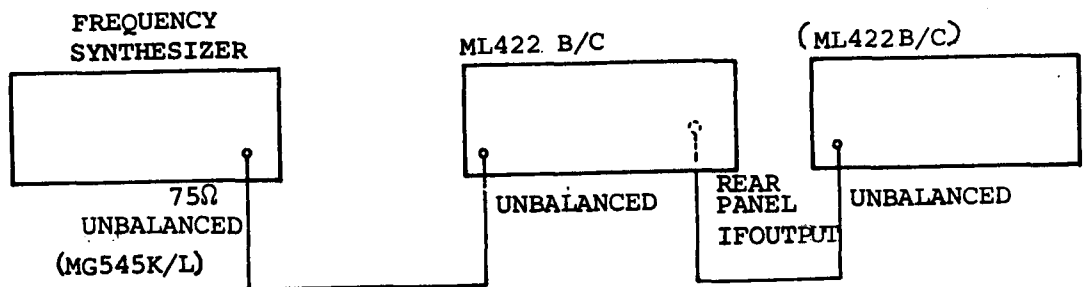

5.8.3 Procedure

1) Connect the output of the synthesizer to the UNBALANCED terminal of the ML422B/C.

2) Set the synthesizer as follows:

- o Output impedance 75 Ω UNBAL
- o Output frequency 100 kHz
- o Output level 0 dBm

3) Set the ML422B/C as follows:

- o IMPEDANCE TERMINATED
- o SLM (BW) 75 Ω
10 kΩ 75 pF
20 Hz

Image Rejection

- o FULL SCALE AUTO OFF
FULL SCALE 0 MHz
-dB
- o RANGE 100 dB
- o UNIT dBm
- o FREQUENCY FREQ 1 0 0 kHz
+dB

4) Send the synthesizer output to the ML422B/C and check that the MEASUREMENT display indicates 0 dBm.

* 56.6 MHz *

5) Set the synthesizer frequency to 113.3 MHz (100 kHz + 2 x 56.6 MHz) and read the MEASUREMENT display value. This value is the image rejection at 56.6 MHz.

* 600 kHz, 25 kHz *

6) Set the synthesizer frequency to 1.3 MHz (100 kHz + 2 x 600 kHz) and 150 kHz (100 kHz + 2 x 2.5 kHz) and read the MEASUREMENT display at each setting. These are the values of image rejection at 600 kHz and 25 kHz.

* 40 kHz (SLM (BW) 48 k) *

7) Connect the ML422B/C IF OUTPUT terminal to the UNBALANCED terminal of the measuring ML422B/C.

8) Set the second ML422B/C as follows:

- o IMPEDANCE TERMINATED 75 Ω
10 kΩ 75 pF
- o SLM (BW) 20 Hz
- o FULL SCALE AUTO
- o UNIT dBm
- o RANGE 100 dB
- o FREQUENCY FREQ 4 0 kHz
+dB

- 9) Set the synthesizer as described in step 2).
- 10) Change the SLM (BW) to 48 K , and set the ML422B/C as described in step 3).
- 11) Perform step 4).
- 12) Receive the output of ML422B/C IF OUTPUT with the measuring ML422B/C and read the MEASUREMENT display value.
- 13) Change the synthesizer output frequency to 20 kHz (100 kHz - 2 x 40 kHz) and read the display value of the measuring ML422B/C.
- 14) Subtract the displayed value of step 12) from the displayed value of step 13). The difference is the image rejection at 40 kHz.

The image rejection measurement frequency is 100 kHz here. However, measurement can also be made at other frequencies.

Phase Jitter

5.9 Phase Jitter

Phase jitter is measured by a two-tone signal measuring method in accordance with CCITT Rec. 0.91/Bell pub. 41009.

5.9.1 Specifications

Compatible with CCITT Rec. 0.91/Bell Pub. 41009

- (1) Input signal frequency range: 1 kHz to 30 MHz
- (2) Input signal level range: -60 dBm to +10 dBm
- (3) Frequency response: 20 Hz to 300 Hz
- (4) Measuring accuracy: $\pm 10\% + 0.5^\circ$ p-p
- (5) Residual phase jitter: $\leq 0.5^\circ$ p-p
- (6) Measuring range: up to 30° p-p
- (7) Resolution: 0.1°

5.9.2 Setup

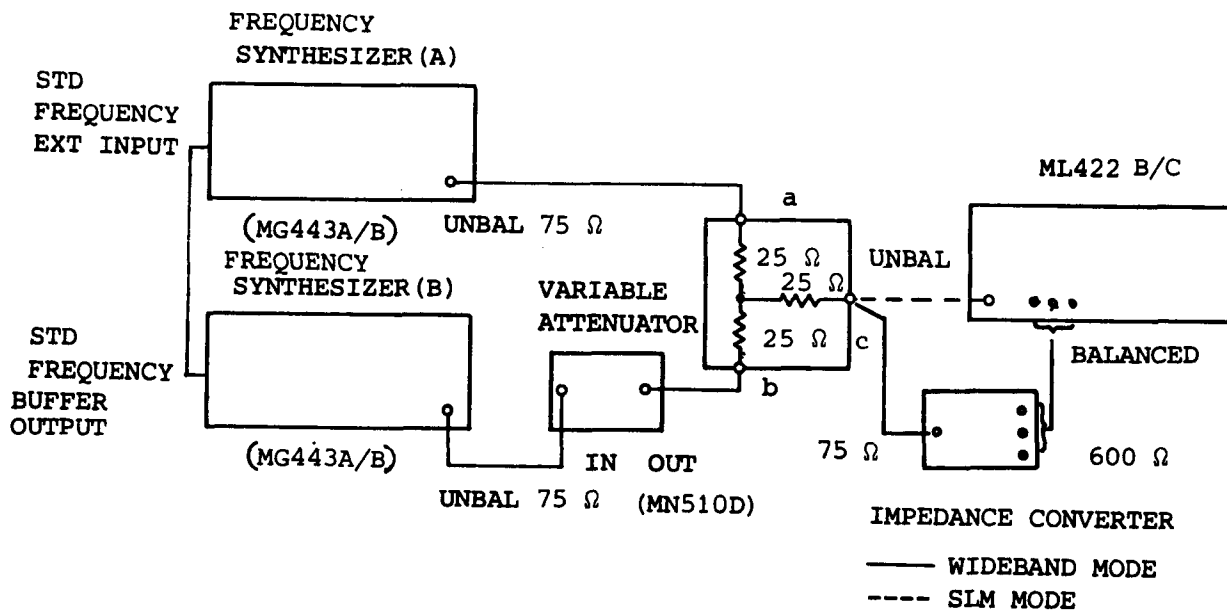

5.9.3 Procedures

5.9.3.1 Wideband

- 1) Connect the UNBAL 75 Ω output of synthesizer(A) to the branch a terminal, connect the UNBAL 75 Ω output of synthesizer (B) to the branch b terminal through an attenuator, and connect the branch c terminal to the ML422B/C BALANCED terminal through an impedance converter.
- 2) Set synthesizer (A) as follows:
 - o Output impedance 75 Ω UNBAL
 - o Output frequency 1000 Hz
 - o Output level 16 dBm
- 3) Set synthesizer (B) as follows:
 - o Output impedance 75 Ω UNBAL
 - o Output frequency 1100 Hz
 - o Output level 16 dBm

* Frequency response measurement *

- 4) Set the variable attenuator to 20 dB.
(Jitter frequency is 100 Hz, and its degree is 11.5°)
- 5) Set the ML422B/C as follows:

IMPEDANCE	TERMINATED	600 Ω 20 k Ω
FULL SCALE	AUTO	
RANGE	20 dB	
MEASUREMENT MODE	WIDEBAND	
- 6) Check that the brancher output signal is being received, then press the MEASUREMENT MODE PHASE JITT key, and read the MEASUREMENT DEG display.

Phase Jitter

- 7) To measure the frequency response of jitter from 20 Hz to 300 Hz, change the output frequency of synthesizer (B) as follows:

Jitter frequency (Hz)	20	100	200	300
Synthesizer (B)	980	900	800	700
Output frequency (Hz)	1,020	1,100	1,200	1,300

Read the MEASUREMENT DEG display for each frequency.

* Measuring accuracy measurement *

- 8) Set synthesizer (B) as described in step 3).
- 9) Set the variable attenuator to 10 dB, 20 dB, 30 dB, 40 dB, and read the ML422B/C MEASUREMENT DEG display at each setting.

Phase jitter for the attenuator set values are shown in the Table below.

Attenuator set value (dB)	10	20	30	40
Phase jitter (degree)	36.9	11.5	3.6	1.2

- 10) Switch the synthesizer (A) and (B) output levels -54 dBm, and read the ML422B/C MEASUREMENT DEG display. (Input level of the ML422B/C is 6 dB smaller than that of the Frequency Synthesizer, because of the insertion loss (6dB) at branch.)

When the level is changed, be sure to check the level with the **WIDEBAND** key. After checking, perform the jitter measurement.

* Residual phase jitter measurement *

- 11) Repeat steps 4) through 6) by resetting the variable attenuator to 80 dB or greater.

Set the output level of synthesizer (B) to -54 dBm, and read the ML422B/C MEASUREMENT DEG display.

5.9.3.2 SLM mode

- 1) Connect the synthesizer (A) UNBAL 75 Ω output to the branch a terminal, connect the synthesizer (B) UNBAL 75 Ω output to the branch b terminal through an UNBAL 75 Ω attenuator, and connect the branch c terminal to the ML422B/C UNBALANCED terminal.
- 2) Set synthesizer (A) as follows:
 - o Output impedance 75 Ω UNBAL
 - o Output frequency 10 kHz
 - o Output level 16 dBm
- 3) Set synthesizer (B) as follows:
 - o Output impedance 75 Ω UNBAL
 - o Output frequency 11 kHz
 - o Output level 16 dBm

* Frequency response measurement *
- 4) Set the variable attenuator to 20 dB.
- 5) Set the ML422B/C as follows:

IMPEDANCE	TERMINATED	75 Ω 10 k Ω 75 pF
MEASUREMENT MODE	3.1 kHz	
FULL SCALE	AUTO	
RANGE	20 dB	
FREQUENCY	FREQ 1 0	kHz +dB
DEMODULATOR	LSB or	USB

Phase Jitter

- 6) Check that the branch output signal is being received, then press the MEASUREMENT MODE **PHASE JITT** key. When DEMODULATOR is set to LSB , change FREQUENCY to a frequency 850 Hz lower than the set frequency. When DEMODULATOR is set to USB , set FREQUENCY to a frequency 850 Hz higher than the set frequency.

This change performs AFC at 1 kHz for the DEMODULATOR frequency.

After checking this, read the MEASUREMENT DEG display.

- 7) To measure the frequency response of jitter from 20 Hz to 300 Hz, change the synthesizer (B) output frequency as follows:

Jitter frequency (Hz)	20	100	200	300
Frequency synthesizer	9,980	9,900	9,800	9,700
Set frequency (Hz)	10,020	10,100	10,200	10,300

* Checking the accuracy of measurement *

- 8) Set synthesizer (B) as described in step 3).
- 9) Change the variable attenuator setting to 10 dB, 20 dB, 30 dB, 40dB, 50 dB, and read the ML422B/C MEASUREMENT DEG display at each setting.

Please jitter for attenuator set values are shown in the Table below.

Attenuator set value (dB)	10	20	30	40	50
Phase jitter (degree)	36.9	11.5	3.6	1.2	0.4

- 10) Change the synthesizer (A) and (B) output levels to -54 dBm, and read the ML422B/C MEASUREMENT DEG display. (Input level of the ML422B/C is 6 dB smaller than that of the frequency Synthesizer, because of the insertion loss (6 dB) at branch.)

When the level is changed, be sure to check the level, with WIDEBAND key. After checking, perform the jitter measurement.

* Residual phase jitter measurement *

- 11) Repeat steps 4) through 6) by resetting the variable attenuator to 80 dBm or more.

Set the synthesizer (B) output level to -54 dBm, and read the ML422B/C MEASUREMENT DEG display.

- 12) Next, perform the measurement at 29.999 MHz same as above steps except frequency setting.

Setting the frequency of the Frequency Synthesizer for frequency response measurement is shown in the table below respectively.

Jitter frequency (Hz)	20	100	200	300
Frequency Synthesizer (B)	29.999M-20	29.999M-100	29.999M-200	29.999M-300
Set frequency (Hz)	29.999M+20	29.999M+100	29.999M+200	29.999M+300

Since it takes about 4 seconds for the measured value to stabilize after each setting, when a setting has been changed, wait 4 seconds before making any measurements.

Weighted Noise and Notch Filter

5.10 Weighted Noise and Notch Filter

The weighting filter used in the ML422B/C complies with CCITT REC P53/Bell Pub. 41009 C-message. The characteristic of the filter is measured.

The characteristic of the 1.010 kHz notch filter used in noise-with-tone measurement is also measured.

5.10.1 Specifications

The weighting filter is compatible with CCITT Rec. P53 (ML422C)/Bell Pub. 41009 C-message (ML422B) response.

In selective mode, weighted noise and the notch filter are superimposed on the 3.1 kHz channel filter response.

In wideband mode, the unit can be used as a normal psophometer.

The notch filter rejects tone signals of 1010 Hz \pm 15 Hz above 50 dB.

5.10.2 Setup



5.10.3 Procedures

* Weighted noise measurement *

- 1) Connect the synthesizer output to the ML422B/C UNBALANCED terminal

- 2) Set the synthesizer as follows:
 - o Output impedance 600 Ω BALANCED
 - o Output frequency 800 Hz
 - o Output level 0 dBm

- 3) Set the ML422B/C as follows:

IMPEDANCE	TERMINATED	600 Ω
		20 kΩ
MEASUREMENT MODE	WIDEBAND	
	WTD	
	NOISE	
FULL SCALE	AUTO	
TANGE	100 dB	
UNIT	dB (X-R)	

- 4) Send the synthesizer output signal to the ML422B/C, press the ML422B/C DATA ENTRY REF(R) MEMORY key, and check that the MEASUREMENT, display indicates 0.0 dB.

- 5) Set the synthesizer output frequency as shown in the table below and read the displayed value at each frequency.
 In this measurement, the synthesizer output signal level accuracy must be approx. ±0.3 dB at 50 Hz to 5,000 Hz.

Measurement Frequency and Specification for Weighting Filter (CCITT Rec. P53)

FREQUENCY (Hz)	NOMINAL VALUE RELATIVE TO VALUE AT 800 Hz (dB)	PERMISSIBLE TOLERANCE
50	-63.0	±2
100	-41.0	
150	-29.0	
200	-21.0	
300	-10.6	
400	- 6.3	
500	- 3.6	±1
600	- 2.0	
800	0.0	0

FREQUENCY (Hz)	NOMINAL VALUE RELATIVE TO VALUE AT 800 Hz (dB)	PERMISSIBLE TOLERANCE
1000	+ 1.0	±1
1200	0.0	
1500	- 1.3	
2000	- 3.0	
2500	- 4.2	
3000	- 5.6	
3500	- 8.5	±2
4000	-15.0	
5000	-36.0	±3

Weighted Noise and Notch Filter

Measurement Frequency and Specification for Weighting Filter (PUB. 41009 C-MESSAGE)

FREQUENCY (Hz)	NOMINAL VALUE RELATIVE TO VALUE AT 800 Hz (dB)	PERMISSIBLE TOLERANCE
60	55.7	±2
100	42.5	
200	25.0	
300	16.5	±1
400	11.4	
500	7.5	
600	4.7	
700	2.7	
800	1.5	
900	0.6	
1000	0	0

FREQUENCY (Hz)	NOMINAL VALUE RELATIVE TO VALUE AT 800 Hz (dB)	PERMISSIBLE TOLERANCE
1200	0.2	±1
1300	0.5	
1500	1.0	
1800	1.3	
2000	1.3	
2500	1.4	
2800	1.9	
3000	2.5	±2
3300	5.2	±3
3500	7.6	
4000	14.5	
4500	21.5	
5000	28.5	

* Notch filter measurement *

- 6) Set the synthesizer output frequency to 1010 Hz.
- 7) Send the synthesizer output signal to the ML422B/C, press the ML422B/C DATA ENTRY **REF (R)**, **MEMORY** key, and check that the MEASUREMENT display indicates 0.0 dB.
- 8) Press the ML422B/C MEASUREMENT MODE **NOISE TONE** key, set the synthesizer output frequency as shown in the table below, and read the displayed value at each frequency.

Frequency measurement values for notch filter measurement

Frequency (Hz)	Diviation
995	-15
1,000	-10
1,005	- 5
1,010	0
1,015	+ 5
1,020	+10
1,025	+15

5.11 Impulse Noise

ML422B/C impulse noise measurement complies with CCITT Rec. 0.71 / Bell Pub. 41109.

5.11.1 Specifications

Compatible with CCITT Rec. 0.71 (ML422C) or Bell Pub. 41009 (ML422B).

Time period : 1 to 99 minutes
 Threshold level setting: 1 dB steps (≥ -80 dBm)
 Dead time : 125 msec. \pm 25 msec. (ML422C)
 143 msec. \pm 25 msec. (ML422B)
 Maximum count : 999

5.11.2 Setup

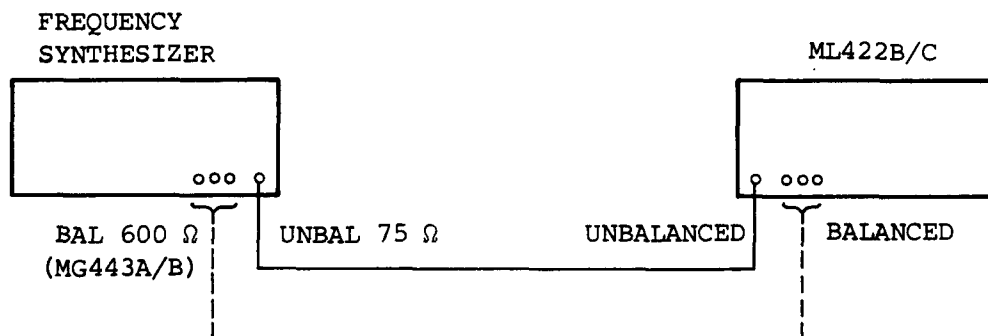

5.11.3 Procedure

1) Connect the synthesizer BAL 600 Ω output to the ML422B/C BALANCED terminal.

2) Set the synthesizer as follows:

	ML422B	ML422C
o Output impedance	600 Ω BAL	600 Ω BAL
o Output frequency	1.7 kHz	1 kHz
o Output level	-3 dBm	0 dBm
o MOD	OFF	OFF

Impulse Noise

- 3) Set the ML422B/C as follows:

IMPEDANCE

RANGE
UNIT
MEASUREMENT MODE

- 4) Send the synthesizer output to the ML422B/C and adjust the synthesizer output to obtain a reading of 0.0 dBm on the MEASUREMENT display.

- 5) Set the ML422B/C as follows:

MEASUREMENT MODE

DATA ENTRY

- 6) Press the key. The START lamp will go out. Read the displayed value.

- 7) Dead time computation

Compute the dead time from as follows:

$$\text{Dead time} = 1/(\text{Number of counts of step 6})/10)$$

(sec.)

- 8) 999 count check

Switch the TIME setting of step 5) to , repeat steps 3) through 6), and read the counted values.

5.12 Tone Search

When unknown hot tone signals are searched by a determined threshold level, the search function measurement is performed.

5.12.1 Specifications

Automatic search for unknown signals or "hot" tones on transmission systems.

Threshold level range: -100 dBm to +0 dBm (BW 3.1 kHz)

Threshold level accuracy: ± 2 dB (scale 20 dB)

Dynamic range: ≥ 50 dB

5.12.2 Setup

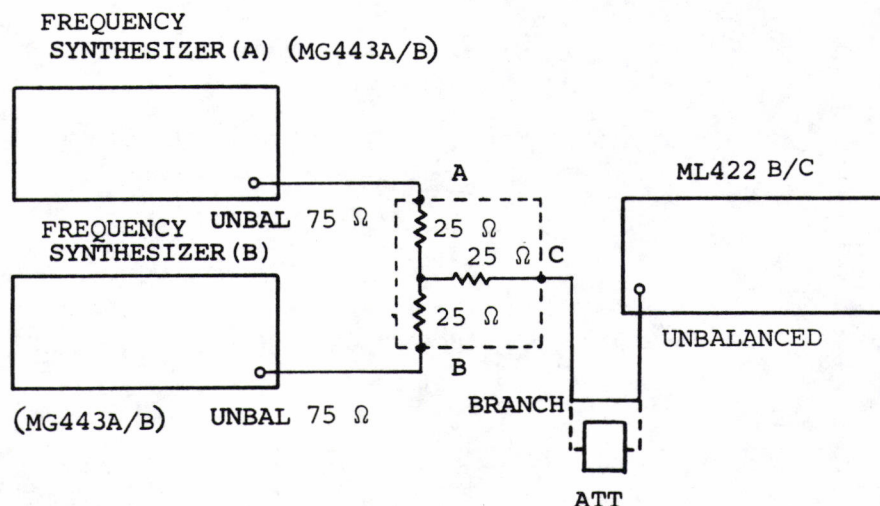

5.12.3 Procedure

- 1) Connect the synthesizer (A) UNBAL output to the branch A terminal, connect the synthesizer (B) UNBAL output to the branch B terminal, and connect the branch C terminal to the ML422B/C UNBALANCED terminal.

Tone Search

- 2) Set synthesizer (A) as follows:
 - o Output impedance 75 Ω UNBAL
 - o Output frequency 120 kHz
 - o Output level 9 dBm

- 3) Set synthesizer (B) as follows:
 - o Output impedance 75 Ω UNBAL
 - o Output frequency 150 kHz
 - o Output level 10 dBm

- 4) Set the ML422B/C as follows:

IMPEDANCE TERMINATED 75 Ω
10 k Ω 75 pF

SLM 3.1 k

RANGE 20 dB

UNIT dBm

* Checking the search function *

- 5) Set the ML422B/C to the TONE SEARCH function as follows:

1. MEASUREMENT TONE SEARCH ON

2. SHIFT ON

3. DATA ENTRY MEMORY (Memory clear)

4. DATA ENTRY START 1 0 0 kHz
+dB

5. DATA ENTRY STOP 6 0 0 kHz
+dB

6. DATA ENTRY THLD 0 MHz
-dB

- 6) Press the SHIFT and MEASUREMENT MODE START keys. The SEARCH function begins between the Start frequency (100 kHz) and Stop frequency (200 kHz). Up to 200 signals which exceed the threshold level, are stored in the memory. At the completion of the measurement, the START lamp goes out.
- 7) Press the key and RECALL keys, to recall the signal which is stored into the memory. By means of this operation, the display FREQUENCY and MEASUREMENT values are changed. When the key is pressed 199 times, the displayed value is repeated
120 kHz, 3 dBm is less than 150 kHz, 4 dBm measurement value depresses 6 dB of output level, caused by the branch loss.
- 8) To check the performance under the threshold level, set the synthesizer (A) and (B) outputs to +3dBm.
- 9) Perform step 5).
- 10) Press the START key. At this time, input signal is unable to find unknown signals, so the FREQUENCY display continues to indicate the STOP frequency.
* Threshold level accuracy measurement *
- 11) Raise the output levels of synthesizers (A) and (B) in 0.5 dB steps, and press the MEASUREMENT MODE START key. "Synthesizer output level + 6 dBm" is the value of the old level level which input level of the ML422B/C can be definitely found.

Tone Search

- 12) To measure the ML422B/C threshold levels at -50 dBm and -100 dBm, adjust the output levels of synthesizers (A) and (B) and measure the threshold level.

For -100 dBm measurement, insert the attenuator as shown in the figure in par. 5.12.2.

* Dynamic range measurement *

- 13) -50 dBm measurement in step 12), increase the (A) and (B) output level of the frequency synthesizer and measure the limit level in normal performance.

5.13 Tracking Output

Output the same frequency which the ML422B/C will receive.
The frequency and level are measured.

5.13.1 Specifications

Frequency range: 800 Hz to 30 MHz
Output level : 0 dBm (to 75 Ω unbalanced)
(Tracking output cannot be used during internal calibration)

5.13.2 Setup

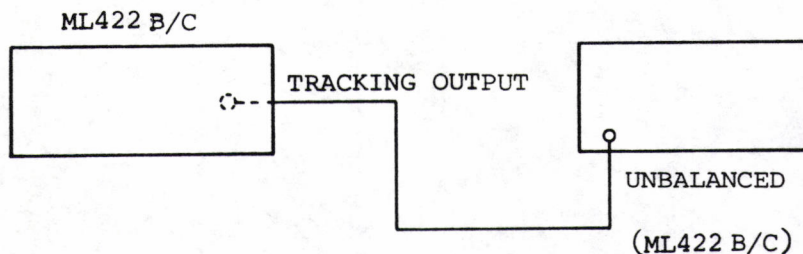

5.13.3 Procedure

- 1) Connect the TRACKING OUTPUT terminal on the rear panel of one ML422B/C to the UNBALANCED terminal of the measuring ML422B/C.

- 2) Set the measuring ML422B/C as follows:

FREQUENCY

- 3) Set the second ML422B/C as follows:

IMPEDANCE

SLM (BW)

UNIT

FREQUENCY

Tracking Output

- 4) Receive the output level of the TRACKING OUTPUT with the measuring ML422B/C.
- 5) Press the **AFC** key of the measuring ML422B/C.
Read the FREQUENCY and MEASUREMENT displays of the measuring ML422B/C.
- 6) Change the frequency of each ML422B/C to 10 kHz, 1 MHz, and 30 MHz, and repeat steps 4) and 5) at each frequency change.

Set the ML422B/C frequency as follows:

FREQ ***1** ***2** ***3** **kHz** **+dB** or **MHz** **-dB**

* Example for setting 123 kHz

External Frequency Reference Input

5.14 External Frequency Reference Input

The internal reference oscillator of the ML422B/C can be synchronized with 1, 2, 5 and 10 MHz external signals. Synchronization with these frequencies is checked. However, the frequency accuracy of the external signal must be $\pm 1 \times 10^{-6}$.

5.14.1 Specifications

The internal reference oscillator can be synchronized with an external signal.

Frequency: 1, 2, 5, 10 MHz

Frequency accuracy: $\pm 1 \times 10^{-6}$

Level: 1 to 5 V p-p

5.14.2 Setup

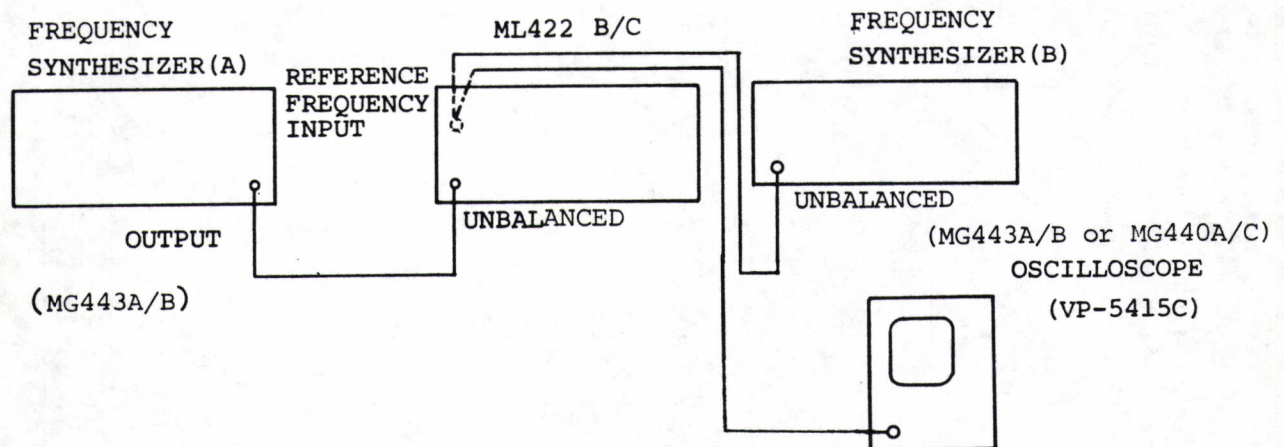

5.14.3 Procedure

- 1) Connect the synthesizer (A) OUTPUT terminal to the ML422B/C UNBALANCED terminal and connect the synthesizer (B) OUTPUT terminal to the REFERENCE FREQUENCY INPUT terminal on the rear panel of the ML422B/C.

External Frequency Reference Input

2) Set synthesizer (A) as follows:

- o Output impedance 75 Ω UNBAL
- o Output frequency 10 MHz
- o Output level 0 dBm

3) Set the ML422B/C as follows:

IMPEDANCE

SLM

FULL SCALE ON

UNIT

DATA ENTRY

REFERENCE FREQUENCY EXT
(On the rear panel)

4) Set synthesizer (B) as follows:

- o Output impedance 75 Ω UNBAL
- o Output frequency 1 MHz
- o Output level 1 V p-p

5) Connect the synthesizer (B) output to the ML422B/C REFERENCE FREQUENCY input connector and also connect to the oscilloscope input as shown in 5.14.2.

Observing the signal which is received by the ML422B/C with an oscilloscope for its amplitude, adjust synthesizer (B) to obtain an output voltage of 1V p-p.

External Frequency Reference Input

- 6) Send the synthesizer (A) signal to the ML422B/C and check that the display indicates 1000000 Hz, and its stabilized. The display may be different from this value by several Hz. However, this is caused by the standard frequency variation.
- 7) Observing the signal which is received by the ML 422B/C with an oscilloscope for its amplitude, adjust synthesizer (B) to obtain an output voltage of 5Vp-p, and check that the ML422B/C FREQUENCY display is stable.
- 8) Change the synthesizer (B) frequency to 2 MHz , 5 MHz, and 10 MHz, and repeat steps 5) through 7). At each frequency, check the ML422B/C displayed frequency values.

SECTION 6

GPIB

6.1 General

The ML422B/C is equipped with a general purpose interface bus (GPIB-compatible with IEEE Standard 488-1978) as standard equipment, remote operation is effected using a personal computer with a GPIB controller (example: Anritsu Packet II, Hp Model 85F, Model 87, Model 9825, and Model 9826). Since the GPIB can connect up to 15 devices on the same bus, a sophisticated automatic test system can be constructed by connecting other devices, such as the Anritsu MG443B synthesizer/level generator, MS010 multifunction selector (scanner), etc., to the same bus.

- Notes: 1) Since each device connected on the GPIB has a unique address, always check the addresses before turning on the power. When the ML422 B/C is shipped, the address is ADDRESS 0 (LISTEN address = SP, TALK address = @ when represented by ASC II code).
- 2) For most practical purposes the GPIB is electrically identical to the IEC625 or HP-IB Standard. The only difference lies in the type of connectors used. The necessary adaptor from GPIB to IEC can be supplied as an optional accessory.

GPIB Functions

6.2 GPIB Functions

The GPIB functions of the ML422B/C selective level meter are described as follows:

SH 1 ... Source Handshake interface function complete capability

AH 1 ... Acceptor Handshake interface function complete capability

T 5 ... Talker interface function complete capability (no address extension)

L 3 ... Listener interface function complete capability (no address extension)

SR 1 ... Service Request interface function complete capability

RL 1 ... Remote Local interface function complete capability

PP 0 ... Parallel Poll interface function no capability

DC 1 ... Device Clear interface function complete capability

DT 1 ... Device Trigger interface function complete capability

C 0 ... Controller interface function no capability

6.3 Address Setting

Setting of device Address is performed by means of the ADDRESS switches located on the ML422B/C rear panel. Since the address is set to 0 when the ML422B/C is shipped, all the ADDRESS switches are in the OFF position. To change the address to 15, set the ADDRESS 1-4 switches to ON and switches 5, TON, and LON to OFF.

Address Setting

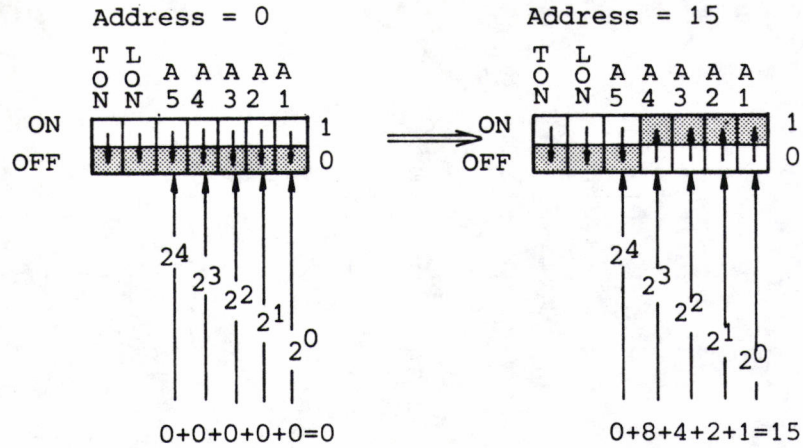
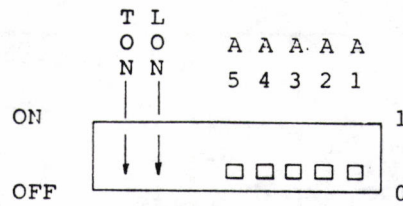

Table 6-1 Address Switch Setting



ASCII Code Character		Address Switches					5-bit Decimal Code
Listen	Talk	A5	A4	A3	A2	A1	
SP	@	0	0	0	0	0	00
!	A	0	0	0	0	1	01
"	B	0	0	0	1	0	02
#	C	0	0	0	1	1	03
\$	D	0	0	1	0	0	04
%	E	0	0	1	0	1	05
&	F	0	0	1	1	0	06
'	G	0	0	1	1	1	07
(H	0	1	0	0	0	08
)	I	0	1	0	0	1	09
*	J	0	1	0	1	0	10
+	K	0	1	0	1	1	11
,	L	0	1	1	0	0	12
-	M	0	1	1	0	1	13
.	N	0	1	1	1	0	14
/	O	0	1	1	1	1	15
0	P	1	0	0	0	0	16
1	Q	1	0	0	0	1	17
2	R	1	0	0	1	0	18
3	S	1	0	0	1	1	19
4	T	1	0	1	0	0	20
5	U	1	0	1	0	1	21
6	V	1	0	1	1	0	22
7	W	1	0	1	1	1	23
8	X	1	1	0	0	0	24
9	Y	1	1	0	0	1	25
:	Z	1	1	0	1	0	26
;	[1	1	0	1	1	27
<	\	1	1	1	0	0	28
=]	1	1	1	0	1	29
>	^	1	1	1	1	0	30

FACTORY-
← SET
ADDRESS

Address Setting

(1) Status byte

A device on the bus sends a status byte message to the active controller whenever it is polled. The individual bits of the status byte indicate the status of the various functions of the device and whether the instrument has requested service.

Table 6-2 True State Definitions of the Bits
in the ML422B/C Status Byte

Bit	True state definition
0	Received unrecognizable string of ASCII characters.
1	Not used
2	Tone memory full
3	Tone not present for noise tone or phase jitter measurements.
4	Measurement is finished (ready to talk).
5	Instrument status is abnormal.
6	This instrument requested service.
7	Not used.

(2) Cable connection

A maximum of 15 devices can be connected to the GPIB system. Care should be taken to limit the length of the connection cable as follows:

- a. No single cable should exceed 2 meters.
- b. Total cable length should not exceed 20 m.

6.4 Device Message Syntax

Device messages (programming codes) consist of a header field, numeric field, and separator field. However, the numeric field is omitted at full scale stepup and stepdown (SU, SD) and frequency stepup, and stepdown (FU, FD). The ML422B/C uses CR LF (ASC II code OD, OA), LF (ASC II code OA), or "," (ASC II code 2C) at the separator field. When many device messages are sent at one time, "," is used. For example, to set the measurement mode to weighted noise and the input impedance to 600 Ω balanced, the message

MA 21, IN 15 [CR][LF] (can be omitted.)

is sent.





Note: Some controllers may use "CR" or EOI line at the separator field. In this case, the ML422B/C does not operate. Since standard controllers have a command which modifies the separator field, change the separator field to CR LF or LF by means of this command.

Device Message Syntax

Formats for Instrument Programming Codes

PANEL CONTROL NAME	INSTRUCTION (ASCII Characters)	AN EXAMPLE (Using Anritsu Packet II)
MEASUREMENT MODE	MA <input type="checkbox"/> <input type="checkbox"/>	WRITE @ 102: "MA2"
20 Hz	1	Device address
3.1 kHz	2	3.1 kHz bandwidth
48 kHz	3	
WIDEBAND	4	
WTD NOISE (Selective)	2 1	WRITE @ 102: "MA23"
NOISE TONE (Selective)	2 2	
PHASE JITTER (Selective)	2 3	Phase jitter (selective)
IMPULSE NOISE (Selective)	2 4	
WTD NOISE (Voice channel)	4 1	
NOISE TONE (Voice channel)	4 2	
PHASE JITTER (Voice channel)	4 3	
IMPULSE NOISE (Voice channel)	4 4	
TONE SEARCH (20 Hz BW)	1 5	
TONE SEARCH (3.1 kHz BW)	2 5	
TONE SEARCH (48 kHz BW)	3 5	
START	S1	WRITE @ 102: "S1" Start
STOP	S0	
INPUT	IN <input type="checkbox"/> <input type="checkbox"/>	WRITE @ 102: "IN11"
TERMINATED	1	
HIGH	2	
75 Ω UNBALANCED	1	75 Ω, unbalanced, terminated
75 Ω BALANCED	2	
124 Ω BALANCED (C: 135)	3	
135 Ω BALANCED (C: 150)	4	
600 Ω BALANCED	5	
FULL SCALE	FS <input type="checkbox"/>	WRITE @ 102: "FS1"
AUTO off	0	
AUTO on	1	Auto on
STEP <input type="checkbox"/>	SU	WRITE @ 102: "SU"
STEP <input type="checkbox"/>	SD	WRITE @ 102: "SD"
RANGE	RG <input type="checkbox"/>	WRITE @ 102: "RG2"
20 dB	1	Device address
100 dB	2	100 dB range

Formats for Instrument Programming Codes (Cont'd)

PANEL CONTROL NAME	INSTRUCTION (ASCII Characters)	AN EXAMPLE (Using Anritsu Packet II)
UNIT dBm (X) dB (0.775 V) dB (X-R)	U <input type="checkbox"/> ↑ 1 2 3	WRITE @ 102: "U2" dB (0.775 V) _____
AVERAGE (AVRG) off on	AV <input type="checkbox"/> ↑ 0 1	WRITE @ 102: "AV1" Average on _____
AFC off on on (One only)	AF <input type="checkbox"/> ↑ 0 1 2	WRITE @ 102: "AFO" AFC off _____
DEMODULATOR off LSB  USB 	DM <input type="checkbox"/> ↑ 0 1 2	WRITE @ 102: "DM2" Upper sideband _____
FREQUENCY STEP  STEP  FINE clockwise counterclockwise	FU FD FF <input type="checkbox"/> ↑ 2 1	WRITE @ 102: "FU" WRITE @ 102: "FD" WRITE @ 102: "FF2" Clockwise (freq. up) _____
DATA ENTRY Frequency (FREQ) Step frequency (STEP FREQ) FULL SCALE Reference (R)	FQ □□...□□ SF □□...□□ SC □□...□□ RR □□...□□	Frequency setting WRITE @ 102: "FQ12345678" (Frequency = 12345678 Hz) WRITE @ 102: "SF4k" (Step frequency = 4 kHz)

Device Message Syntax

Formats for Instrument Programming Codes (Cont'd)

PANEL CONTROL NAME	INSTRUCTION (ASCII Characters)	AN EXAMPLE (Using Anritsu Packet II)
START frequency	ST □□-□□	Full scale setting WRITE @ 102: "SC-25" (Full scale is -25 dBm/dB (0.775 V)); minimum step 5 dB
STOP frequency	SP □□-□□	
Threshold level (THLD)	RT □□□	Reference (R) setting WRITE @ 102: "RR-12.34" (Reference (R) is -12.34 dBm/dB (0.775 V))
TIME duration	DT □□□	
MEMORY	MM □□	Memory setting WRITE @ 102: "MM15" (Panel condition is stored into memory address 15)
RECALL	RC □□	
0	0	Recall WRITE @ 102: "RC15" (Panel condition is recalled from memory address 15)
1	1	
2	2	Threshold level setting WRITE @ 102: "RT-59" (Threshold level is -59 dBm/dB (0.775 V)); minimum step 1 dB
3	3	
4	4	Time duration setting WRITE @ 102: "DT10M" "Time duration is 10 minutes) WRITE @ 102; "DT 12.34M." (Time duration is 12 minutes 34 sec.)
5	5	
6	6	k Hz
7	7	
8	8	M Hz
9	9	
.	.	SEC
kHz	K	MINU
MHz	M	
SEC	S	
MINU	M	

Device Message Syntax

Formats for Instrument Programming Codes (Cont'd)

PANEL CONTROL NAME	INSTRUCTION (ASCII Characters)	AN EXAMPLE (Using Anritsu Packet II)
High level tone search	MS1	WRITE @ 102: "MS1"
Low level tone search	MS2	WRITE @ 102: "MS2"
Scan measure	MS3	WRITE @ 102: "MS3"
Tone memory clear	MC	WRITE @ 102: "MC"
Scan step freq. size	SS	WRITE @ 102: "SS3K" Scan step freq. = 3kHz
MEASUREMENT data set	TIL	WRITE @ 102: "TIL" READ @ 102 : X (If X = 999 the measurement is out of range)
Number of tone	TCN	WRITE @ 102: "TCN" READ @ 102: C
Tone memory recall	TMM	WRITE @ 102: "TMM" READ @ 102: F READ @ 102: L
OVER LOAD data set	TOV	WRITE @ 102: "TOV" READ @ 102: V (V = 1; overloaded V = 0; not overloaded)
FREQUENCY data set	TFQ	WRITE @ 102: "TFQ" READ @ 102: F (F is frequency in Hz)
MEASUREMENT END data set	TME	WRITE @ 102: "TME" READ @ 102: E E=1; measurement end E=0; measuring

6.5 GPIB System

Packet II

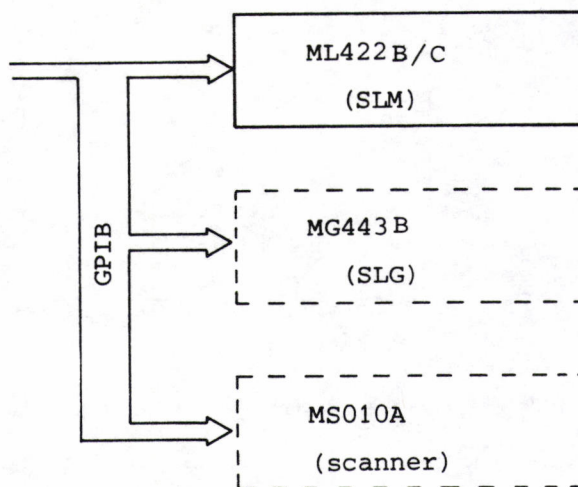
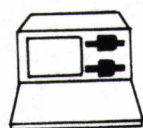

Fig. 6-1

The minimum automatic measuring set configuration consists of the ML422B/C and a controller (Anritsu Packet II or equivalent). The functions can also be improved by combining an MG443B synthesizer/level generator and an MS010A scanner.

Note: Anritsu offers FDM surveillance software for the configuration given above.

Programming Examples

6.6 Programming Examples

Example 1

```
100 !*****
110 !***   SAMPLE PROGRAM           ***
120 !***
130 !***   ML422   BAND WIDTH SET   ***
140 !***
150 !***           Packet ][       ***
160 !*****
170 !
180 LET SLM=100!----- SELECTIV LEVEL METER ADDRES SET
190 !
200 CLEAR
205 !----- BAND WIDTH MENU
210 PRINT " BAND WIDTH           "
220 PRINT "   20 Hz ----- 1"
230 PRINT "   3.1KHz ----- 2"
240 PRINT "   4B KHz ----- 3"
250 PRINT "WIDE BAND ----- 4"
260 !
265 INPUT MODE
266 !
270 SELECT MODE!--- SELECT GP-IB PROGRAMMING CODES
280 CASE 1
290 LET CMD$="MA1"
300 CASE 2
310 LET CMD$="MA2"
320 CASE 3
330 LET CMD$="MA3"
340 CASE 4
350 LET CMD$="MA4"
380 CASE ELSE
390 GO TO 200
400 END SELECT
410 !
420 !
430 WRITE @SLM:CMD$!----- SET BAND WIDTH
440 !
```

Example 2

```

100 !*****
110 !***   SAMPLE PROGRAM           ***
120 !***
130 !***   ML422   IMPEDANCE   SET   ***
140 !***
150 !***           Packet ][       ***
160 !*****
170 !
180 LET SLM=100!----- SELECTIV LEVEL METER ADDRESS SET
190 !
200 CLEAR
205 !----- IMPEDANCE MENU
210 PRINT " 75 OHM UNBALANCE----- 1"
220 PRINT " 75 OHM BALANCE ----- 2"
230 PRINT "124 OHM BALANCE ----- 3"
240 PRINT "150 OHM BALANCE ----- 4"
250 PRINT "600 OHM BALANCE ----- 5"
260 !
265 INPUT IMPEDANCE
266 !
270 SELECT IMPEDANCE!--- SELECT GP-IB PROGRAMMING CODES
280 CASE 1
290 LET IMP$="IN 11"
300 CASE 2
310 LET IMP$="IN 12"
320 CASE 3
330 LET IMP$="IN 13"
340 CASE 4
350 LET IMP$="IN 14"
360 CASE 5
370 LET IMP$="IN 15"
380 CASE ELSE
390 GO TO 200
400 END SELECT
410 !
420 !
430 WRITE @SLM:IMP$!----- SET IMPEDANCE
440 !

```

Programming Examples

Example 3

```
100 !*****
110 !***  SAMPLE PROGRAM          ***
120 !***          ***
130 !***    ML422 MEASUREMENT MODE SET  ***
140 !***          ***
150 !***      Packet  ][          ***
160 !*****
170 !
180 LET SLM=100!----- SELECTIV LEVEL METER ADDRESS SET
190 !
200 CLEAR
210 !----- MEASUREMENT MODE MENU
220 PRINT " MEASUREMENT MODE          "
230 PRINT "WTD NOISE ----- 1"
240 PRINT "NOISE TONE ----- 2"
250 PRINT "PHASE JITTER ----- 3"
260 PRINT "IMPULSE NOISE ----- 4"
270 !
280 INPUT MODE
290 !
300 !----- MEASUREMENT MODE MENU2
310 PRINT " MEASUREMENT MODE          "
320 PRINT " SELECTIV (3.1KHz) --- 1"
330 PRINT "VOICE CHANNEL (WIDEBAND)--- 2"
340 INPUT MODE2
350 !
360 SELECT MODE2
370 CASE 1
380 LET CMD2$="MA2"!----- BW 3.1K
390 !
400 CASE 2
410 LET CMD2$="MA4"!----- WIDE BAND
420 !
430 CASE ELSE
440 GO TO 200
450 END SELECT
460 !
470 !
480 !
490 SELECT MODE!--- SELECT GP-IB PROGRAMMING CODES
500 CASE 1
510 LET CMD$="1"!----- WTD NOISE
520 CASE 2
530 LET CMD$="2"!----- NOISE TONE
540 CASE 3
550 LET CMD$="3"!----- PHASE JITTER
560 CASE 4
570 LET CMD$="4"!----- IMPULSE NOISE
580 CASE ELSE
590 GO TO 200
600 END SELECT
610 !
620 !
630 WRITE @SLM:CMD2$&CMD$!----- SET BAND WIDTH
640 !
```

Example 4

```

100 !*****
110 !***  CHANNEL PLAN  No. SET      ***
120 !***                               PROG 1      ***
130 !*****
140 !
150 LET SLM=100
160 DCL @SLM
170 !
180 INPUT PROMPT "      CHANNEL NO .":CH
190 INPUT PROMPT "      GROUP  NO .":G
200 INPUT PROMPT "SUPER  GROUP NO .":SG
210 INPUT PROMPT "MASTER GROUP NO .":MG
220 WRITE @SLM USING "C2,FZ1,FZ2,FZ1,FZ2": "CP",MG,SG,G,CH

```

Example 5

```

100 !*****
110 !***  CHANNEL PLAN  No. SET      ***
120 !***                               PROG 2      ***
130 !*****
140 !
150 LET SLM=100
160 DCL @SLM
170 !
180 INPUT PROMPT "      CHANNEL NO .":CH
190 WRITE @SLM USING "C2,FZ2": "CH",CH
195 !
200 INPUT PROMPT "      GROUP  NO .":G
210 WRITE @SLM USING "C2,FZ1": "GR",G
215 !
220 INPUT PROMPT "SUPER  GROUP NO .":SG
230 WRITE @SLM USING "C2,FZ2": "SG",SG
235 !
240 INPUT PROMPT "MASTER GROUP NO .":MG
250 WRITE @SLM USING "C2,FZ1": "MG",MG

```

Programming Examples

Example 6

```
100 !*****
110 !***          ***
120 !***   FREQUENCY STEP MEASURE   ***
130 !***          ***
140 !***   Control by Packet][   ***
150 !*****
160 LET SLM=100!----- SELECTIV LEVEL METER ADDRESS
170 !
180 DCL @SLM!----- DEVICE CLEAR
190 !
200 !
210 INPUT PROMPT "START FREQUENCY (KHz)":STARTF
220 INPUT PROMPT "STOP FREQUENCY (KHz)":STOPF
230 INPUT PROMPT "STEP FREQUENCY (KHz)":STEPF
240 !
250 WRITE @SLM:"MA2"!----- TONE SEARCH BW 3.1 K
260 WRITE @SLM:"FQ",STARTF*1000!----- START FREQUENCY SET
270 WRITE @SLM:"SF",STEPF*1000!----- STEP FREQUENCY SET
280 !
290 ! MEASUREMENT START
300 WRITE @SLM:"MS1"!----- MEAS START
310 WRITE @SLM:"S1"!----- START LAMP ON
320 !
330 !----- STATUS WAIT LOOP
340 WRITE @SLM:"TME"!----- TALK MEASURE END
350 READ @SLM:TME
360 IF TME=1 THEN 380 ELSE 340
370 !
380 WRITE @SLM:"TFQ"!----- TALK FREQUENCY
390 READ @SLM:FREQ
400 WRITE @SLM:"TIL"!----- TALK INPUT LEVEL
410 READ @SLM:LEVEL
420 !-----
430 PRINT
440 PRINT USING "FREQUENCY #####.### KHz ":FREQ/1000
450 PRINT USING "INPUT LEVEL ####.## dB ":LEVEL
460 !
470 IF FREQ/1000<STOPF THEN
480 !
490 WRITE @SLM:"FU"!----- FREQUENCY STEP UP
500 GO TO 290
510 END IF
520 END
```

Example 7 (1)

```

100 !*****
110 !***
120 !*** AUTO MEASURE STATUS Ex.1 ***
130 !*** (MS3) ***
140 !*** ROM Ver 1.00 - 1.01 -1.02 ***
150 !*** Control by Packet]I ***
160 !*****
170 !
180 !
190 LET SLM=100!----- Selectiv level meter address
200 !
210 LET STARTF=10!----- Start frequency initialize set
220 LET STOPF=200!----- Stop frequency
230 LET STEPF=1!----- step frequency
240 !
250 !
260 DCL @SLM!----- Device Clear
270 STATUS @SLM:SPOLL
280 !
290 PRINT "----- AUTO MEASURE -----"
300 INPUT PROMPT "START FREQUENCY (KHz)":STARTF
310 INPUT PROMPT "STOP FREQUENCY (KHz)":STOPF
320 INPUT PROMPT "STEP FREQUENCY (KHz)":STEFF
330 PRINT
340 !
350 WRITE @SLM:"MA2"!- Band width 3.1kHz
360 WRITE @SLM:"ST",STARTF*1000!----- Start frequency set
370 WRITE @SLM:"SP",STOPF*1000!----- Stop frequency set
380 WRITE @SLM:"SS",STEFF*1000!----- Step frequency set
390 !
400 ! Measure start
410 !
420 WRITE @SLM:"MS3"!----- AUTO Measure start
430 !
440 STATUS @SLM:SPOLL!----- Status wait loop
450 !
460 !
470 IF BIT(2,SPOLL) THEN!----- Memoru full ?
480 GO SUB RECALL
490 GO TO 420!----- Auto measure again
500 END IF
510 !
520 IF NOT BIT(4,SPOLL) THEN!----- measure is finished ?
530 GO SUB RECALL
540 PRINT "----- Measure end -----"
550 STOP
560 END IF
570 !
580 GO TO 440!----- Status wait loop end
590 STOP
600 !
610 ! Auto measure recall sub routine
620 RECALL: !
630 WRITE @SLM:"TCN"!----- Memory counter
640 READ @SLM:COUNTER
650 !
660 PRINT "COUNTER=";COUNTER
670 IF COUNTER=0 THEN GO TO RECALL_END
680 WRITE @SLM:"TMM"!----- Talk memory set
690 !
700 FOR I=1 TO COUNTER
710 READ @SLM:FREQ
720 READ @SLM:LEVEL
730 PRINT I,"FREQ:";FREQ,"LEVEL:";LEVEL
740 NEXT I
750 !
760 WRITE @SLM:"MC"!----- Auto measure memory clear
770 RECALL_END: !
780 RETURN
790 !
800 END

```

Programming Examples

Example 7 (2)

```
100 '*****
110 '***
120 '*** AUTO MEASURE SRQ Ex.2 ***
130 '*** (MS3) ***
140 '*** ROM Ver 1.00 - 1.01 -1.02 ***
150 '*** Control by FacetII ***
160 '*****
170 !
180 COM SLM,FLAG,SPOLL
190 !
200 LET SLM=100'----- Selectiv level meter address
210 !
220 LET STARTF=10'----- Start frequency initialize set
230 LET STOPF=900'----- Stop frequency
240 LET STEFF=1'----- step frequency
250 !
260 DCL @SLM'----- Device Clear
270 WRITE @SLM:"SR1'"----- Service request on
280 STATUS @SLM:SPOLL
290 !
300 'GP-IB SRQ Interrupt initialize
310 PROCESS EVENT GPIB"@01,02"
320 START GPIBSRQ
330 CONNECT EVENT GPIB
340 !
350 !
360 PRINT "----- AUTO MEASURE -----"
370 INPUT PROMPT "START FREQUENCY (kHz)":STARTF
380 INPUT PROMPT "STOP FREQUENCY (kHz)":STOPF
390 INPUT PROMPT "STEP FREQUENCY (kHz)":STEFF
400 PRINT
410 !
420 WRITE @SLM:"MA2"!-- Band width 3.1kHz
430 WRITE @SLM:"ST",STARTF*1000'----- Start frequency set
440 WRITE @SLM:"SP",STOPF*1000'----- Stop frequency set
450 WRITE @SLM:"SS",STEFF*1000'----- Step frequency set
460 !
470 ! Measure start
480 !
490 WRITE @SLM:"MS3"!'----- AUTO measure start
500 !
510 IF FLAG<>1 THEN 510'----- Status wait loop
520 !
530 !
540 IF BIT(2,SPOLL) THEN'----- Memoru full ?
550 LET FLAG=0
560 GO SUB RECALL
570 GO TO 490'----- Auto measure again
580 END IF
590 !
600 GO SUB RECALL
610 PRINT "----- Measure end -----"
620 STOP
630 !
640 ! Auto measure recall sub routine
650 RECALL: !
660 WRITE @SLM:"TCN"!'----- Memory counter
670 READ @SLM:COUNTER
680 !
690 PRINT "COUNTER=";COUNTER
700 IF COUNTER=0 THEN GO TO RECALL_END
710 WRITE @SLM:"TMM"!'----- Talk memory set
720 !
730 FOR I=1 TO COUNTER
740 READ @SLM:FREQ
750 READ @SLM:LEVEL
760 PRINT I,"FREQ:";FREQ,"LEVEL:";LEVEL
770 NEXT I
780 !
790 WRITE @SLM:"MC"!'----- Auto measure memory clear
800 RECALL_END: !
810 RETURN
820 !
830 END
840 !
850 PARACT GPIBSRQ URGENCY 50
860 COM SLM,FLAG,SPOLL
870 !
880 WAIT EVENT GPIB
890 STATUS @SLM:SPOLL
900 PRINT "----- SRQ ON -----"
910 !
920 LET FLAG=1
930 GO TO 880
940 END PARACT
```

Example 8 (1)

```

100 !*****
110 !***
120 !*** TONE SEARCH MEASURE Ex.1 ***
130 !*** STATUS WAIT ***
140 !*** NORMAL (MS1) ***
150 !*** ROM Ver 1.00 - 1.01 -1.02 ***
160 !*** Control by PacketJL ***
170 !*****
180 !
190 !
200 LET SLM=100!----- Selectiv level meter address
210 !
220 LET STARTF=10!----- Start frequency initialize set
230 LET STOPF=200!----- Stop frequency
240 LET STEPF=1!----- step frequency
250 LET THLDLV=-10!----- Threshold level
260 !
270 !
280 DCL @SLM!----- Device Clear
290 STATUS @SLM:SPOLL
300 !
310 PRINT "----- TONE SEARCH MEASURE -----"
320 INPUT PROMPT "START FREQUENCY (KHz)":STARTF
330 INPUT PROMPT "STOP FREQUENCY (KHz)":STOPF
340 INPUT PROMPT "STEP FREQUENCY (KHz)":STEFF
350 PRINT
360 INPUT PROMPT "THRESHOLD LEVEL (dB)":THLDLV
370 !
380 WRITE @SLM:"MA25"!- Band width 3.1kHz and tone search set
390 WRITE @SLM:"RT",THLDLV!----- Threshold level set
400 WRITE @SLM:"ST",STARTF#1000!---- Start frequency set
410 WRITE @SLM:"SF",STOPF#1000!---- Stop frequency set
420 WRITE @SLM:"SS",STEFF#1000!---- Step frequency set
430 !
440 ! Measure start
450 !
460 WRITE @SLM:"MS1"!----- Measure start
470 !
480 STATUS @SLM:SPOLL!----- Status wait loop
490 !
500 IF BIT(2,SPOLL) THEN!----- Memoru full ?
510 GO SUB RECALL
520 GO TO 460!----- Tone search again
530 END IF
540 !
550 IF NOT BIT(4,SPOLL) THEN!----- measure is finished ?
560 GO SUB RECALL
570 PRINT "----- Measure end -----"
580 STOP
590 END IF
600 !
610 GO TO 480!----- Status wait loop end
620 STOP
630 !
640 ! Hot tone recall sub routine
650 RECALL: !
660 WRITE @SLM:"TCN"!----- Memory counter
670 READ @SLM:COUNTER
680 !
690 PRINT "COUNTER=";COUNTER
700 IF COUNTER=0 THEN GO TO RECALL_END
710 WRITE @SLM:"TMM"!----- Talk memory set
720 !
730 FOR I=1 TO COUNTER
740 READ @SLM:FREQ
750 READ @SLM:LEVEL
760 PRINT I,"FREQ:";FREQ,"LEVEL:";LEVEL
770 NEXT I
780 !
790 WRITE @SLM:"MC"!----- Hot tone memory clear
800 RECALL_END: !
810 RETURN
820 !
830 END

```

Programming Examples

Example 8 (2)

```

100 !*****
110 !***                                     ***
120 !*** TONE SEARCH MEASURE Ex.2         ***
130 !***           STATUS WAIT           ***
140 !***           INVERT (MS2)          ***
150 !*** ROM Ver 1.00 - 1.01 -1.02       ***
160 !***           Control by Packet]    ***
170 !*****
180 !
190 !
200 LET SLM=100!----- Selectiv level meter address
210 !
220 LET STARTF=10!----- Start frequency initialize set
230 LET STOPF=200!----- Stop frequency
240 LET STEPF=1!----- step frequency
250 LET THLDLV=-10!----- Threshold level
260 !
270 !
280 DCL @SLM!----- Device Clear
290 STATUS @SLM:SPOLL
300 !
310 PRINT "----- TONE SEARCH MEASURE -----"
320 INPUT PROMPT "START FREQUENCY (KHz)":STARTF
330 INPUT PROMPT "STOP FREQUENCY (KHz)":STOPF
340 INPUT PROMPT "STEP FREQUENCY (KHz)":STEPF
350 PRINT
360 INPUT PROMPT "THRESHOLD LEVEL (dB)":THLDLV
370 !
380 WRITE @SLM:"MA25"!- Band width 3.1kHz and tone search set
390 WRITE @SLM:"RT",THLDLV!----- Threshold level set
400 WRITE @SLM:"ST",STARTF*1000!---- Start frequency set
410 WRITE @SLM:"SP",STOPF*1000!---- Stop frequency set
420 WRITE @SLM:"SS",STEPF*1000!---- Step frequency set
430 !
440 ! Measure start
450 !
460 !
470 WRITE @SLM:"MS2"!----- Invert measure start
480 !
490 !
500 STATUS @SLM:SPOLL!----- Status wait loop
510 !
520 !
530 IF BIT(2,SPOLL) THEN!----- Memoru full ?
540 GO SUB RECALL
550 GO TO 470!----- Tone search again
560 END IF
570 !
580 IF NOT BIT(4,SPOLL) THEN!----- measure is finished ?
590 GO SUB RECALL
600 PRINT "----- Measure end -----"
610 STOP
620 END IF
630 !
640 GO TO 500!----- Status wait loop end
650 STOP
660 !
670 ! Hot tone recall sub routine
680 RECALL: !
690 WRITE @SLM:"TCN"!----- Memory counter
700 READ @SLM:COUNTER
710 !
720 PRINT "COUNTER=";COUNTER
730 IF COUNTER=0 THEN GO TO RECALL_END
740 WRITE @SLM:"TMM"!----- Talk memory set
750 !
760 FOR I=1 TO COUNTER
770 READ @SLM:FREQ
780 READ @SLM:LEVEL
790 PRINT I,"FREQ:";FREQ,"LEVEL:";LEVEL
800 NEXT I
810 !
820 WRITE @SLM:"MC"!----- Hot tone memory clear
830 RECALL_END: !
840 RETURN
850 !
860 END

```

Example 8 (3)

```

100 !*****
110 !***
120 !*** TONE SEARCH MEASURE Ex.3 ***
130 !*** SRQ WAIT ***
140 !*** NORMAL (MS1) ***
150 !*** ROM Ver 1.00 - 1.01 -1.02 ***
160 !*** Control by PacketIC ***
170 !*****
180 !
190 COM SLM,FLAG,SPOLL
200 !
210 LET SLM=100!----- Selectiv level meter address
220 !
230 LET STARTF=10!----- Start frequency initialize set
240 LET STOFF=200!----- Stop frequency
250 LET STEFF=1!----- step frequency
260 LET THLDLV=-10!----- Threshold level
270 !
280 DCL @SLM!----- Device Clear
290 WRITE @SLM:"SR1"!----- Service request on
300 STATUS @SLM:SPOLL
310 !
320 !GP-IB SRQ Interrupt initialize
330 PROCESS EVENT GPIB"@01,02"
340 START GPIBSRQ
350 CONNNECT EVENT GPIB
360 !
370 !
380 PRINT "----- TONE SEARCH MEASURE -----"
390 INPUT PROMPT "START FREQUENCY (KHz)":STARTF
400 INPUT PROMPT "STOP FREQUENCY (KHz)":STOFF
410 INPUT PROMPT "STEP FREQUENCY (KHz)":STEFF
420 PRINT
430 INPUT PROMPT "THRESHOLD LEVEL (dB)":THLDLV
440 !
450 WRITE @SLM:"MA25"!- Band width 3.1KHz and tone search set
460 WRITE @SLM:"RT",THLDLV!----- Threshold level set
470 WRITE @SLM:"ST",STARTF*1000!----- Start frequency set
480 WRITE @SLM:"SP",STOFF*1000!----- Stop frequency set
490 WRITE @SLM:"SS",STEFF*1000!----- Step frequency set
500 !
510 ! Measure start
520 !
530 WRITE @SLM:"MS1"!----- Measure start
540 !
550 IF FLAG<>1 THEN 550!----- Status wait loop
560 !
570 !
580 IF BIT(2,SPOLL) THEN!----- Memoru full ?
590 LET FLAG=0
600 GO SUB RECALL
610 GO TO 530!----- Tone search again
620 END IF
630 !
640 GO SUB RECALL
650 PRINT "----- Measure end -----"
660 STOP
670 !
680 ! Hot tone recall sub routine
690 RECALL: !
700 WRITE @SLM:"TCN"!----- Memory counter
710 READ @SLM:COUNTER
720 !
730 PRINT "COUNTER=";COUNTER
740 IF COUNTER=0 THEN GO TO RECALL_END
750 WRITE @SLM:"TMM"!----- Talk memory set
760 !
770 FOR I=1 TO COUNTER
780 READ @SLM:FREQ
790 READ @SLM:LEVEL
800 PRINT I,"FREQ:";FREQ,"LEVEL:";LEVEL
810 NEXT I
820 !
830 WRITE @SLM:"MC"!----- Hot tone memory clear
840 RECALL_END: !
850 RETURN
860 !
870 END
880 !
890 PARACT GPIBSRQ URGENCY 50
900 COM SLM,FLAG,SPOLL
910 !
920 WAIT EVENT GPIB
930 !
940 STATUS @SLM:SPOLL
950 PRINT "----- SRQ ON -----"
960 LET FLAG=1
970 GO TO 920
980 END PARACT

```

Programming Examples

Example 8 (4)

```
100 !*****
110 !***
120 !*** TONE SEARCH MEASURE Ex.4 ***
130 !*** SRQ WAIT ***
140 !*** INVERT (MS2) ***
150 !*** RDM Ver 1.00 - 1.01 -1.02 ***
160 !*** Control by PacketJ! ***
170 !*****
180 !
190 COM SLM,FLAG,SPOLL
200 !
210 LET SLM=100!----- Selectiv level meter address
220 !
230 LET STARTF=10!----- Start frequency initialize set
240 LET STOPF=900!----- Stop frequency
250 LET STEPF=1!----- step frequency
260 LET THLDLV=-10!----- Threshold level
270 !
280 DCL @SLM!----- Device Clear
290 WRITE @SLM:"SRI"!----- Service request on
300 STATUS @SLM:SPOLL
310 !
320 !
330 !GP-IB SRQ Interrupt initialize
340 PROCESS EVENT GPIB"@01,02"
350 START GPIBSRQ
360 CONNECT EVENT GPIB
370 !
380 !
390 PRINT "----- TONE SEARCH MEASURE -----"
400 INPUT PROMPT "START FREQUENCY (KHz)":STARTF
410 INPUT PROMPT "STOP FREQUENCY (KHz)":STOPF
420 INPUT PROMPT "STEP FREQUENCY (KHz)":STEPF
430 PRINT
440 INPUT PROMPT "THRESHOLD LEVEL (dB)":THLDLV
450 !
460 WRITE @SLM:"MA25"!- Band width 3.1kHz and tone search set
470 WRITE @SLM:"RT",THLDLV!----- Threshold level set
480 WRITE @SLM:"ST",STARTF+1000!---- Start frequency set
490 WRITE @SLM:"SP",STOPF+1000!---- Stop frequency set
500 WRITE @SLM:"SS",STEPF+1000!---- Step frequency set
510 !
520 ! Measure start
530 !
540 WRITE @SLM:"MS2"!----- Invert measure start
550 !
560 IF FLAG<>1 THEN GO TO 560!----- Status wait loop
570 !
580 !
590 IF BIT(2,SPOLL) THEN!----- Memoru full ?
600 LET FLAG=0
610 GO SUB RECALL
620 GO TO 540!----- Tone search again
630 END IF
640 !
650 GO SUB RECALL
660 PRINT "----- Measure end -----"
670 STOP
680 !
690 ! Hot tone recall sub routine
700 RECALL: !
710 WRITE @SLM:"TCN"!----- Memory counter
720 READ @SLM:COUNTER
730 !
740 PRINT "COUNTER=";COUNTER
750 IF COUNTER=0 THEN GO TO RECALL_END
760 WRITE @SLM:"TMN"!----- Talk memory set
770 !
780 FOR I=1 TO COUNTER
790 READ @SLM:FREQ
800 READ @SLM:LEVEL
810 PRINT I,"FREQ:";FREQ,"LEVEL:";LEVEL
820 NEXT I
830 !
840 WRITE @SLM:"MC"!----- Hot tone memory clear
850 RECALL_END: !
860 RETURN
870 !
880 END
890 !
900 PARACT GPIBSRQ URGENCY 50
910 COM SLM,FLAG,SPOLL
920 !
930 WAIT EVENT GPIB
940 !
950 STATUS @SLM:SPOLL
960 PRINT "-----SRQ ON -----"
970 !
980 LET FLAG=1
990 GO TO 930
1000 END PARACT
```

Example 9

```

100 !*****
110 !***  SAMPLE PROGRAM          ***
120 !***  ML422  IMPULSE NOISE (TME)  ***
130 !***                                     ***
140 !***          Packet ][          ***
150 !*****
160 LET SLM=100!----- SELECTIVE LEVEL METER ADDRESS
170 DCL @SLM!----- DEVICE CLEAR
180 !
190 INPUT PROMPT "FREQUENCY (KHz)":FREQ
200 INPUT PROMPT "INTERVAL TIME Ex. MM.SS":DTIME
210 INPUT PROMPT "THRESHOLD LEVEL (dB)":THLDLEVEL
220 !
230 !
240 WRITE @SLM:"FQ",FREQ*1000!-- FREQUENC SET
250 WRITE @SLM:"MA24"!----- BW 3.1KHz & IMPULSE NOISE
260 WRITE @SLM:"DT",DTIME,"M"!-- TIME SET
270 !
280 WRITE @SLM:"S1"!----- START LAMP ON
290 TRG @SLM!----- TRIGGER SLM
300 !----- WAIT LOOP
310 WRITE @SLM:"TME"!----- TALK MEASURE END
320 READ @SLM:TME
330 IF TME<>1 THEN 310
340 !
350 WRITE @SLM:"TIL"!----- TALK COUNT
360 READ @SLM:COUNT
370 !
380 LET COUNT=COUNT*100
390 !
400 PRINT USING "COUNT #### FREQ #####.### KHz":LEVEL,FREQ
410 END

```

Programming Examples

Example 10

```
100 !*****
110 !***  SAMPLE PROGRAM          ***
120 !***  ML422  IMPULSE NOISE (SRQ)  ***
130 !***
140 !***          Packet J[      ***
150 !*****
160 COM SLM,FLAG!----- COMMON VARIABLE
170 LET SLM=100!----- SELECTIVE LEVEL METER ADDRESS
180 DCL @SLM!----- DEVICE CLEAR
190 !
200 INPUT PROMPT "FREQUENCY (KHz)":FREQ
210 INPUT PROMPT "INTERVAL TIME Ex. MM.SS":DTIME
220 INPUT PROMPT "THRESHOLD LEVEL (dB)":THLDLEVEL
230 !
240 !----- Hz to KHz
250 LET FREQ=TFREQ*1000
260 !
270 WRITE @SLM:"SR1"
280 STATUS @SLM:A
290 !
300 PROCESS EVENT GPIB"@01,02"
310 START GPIBSRQ
320 CONNECT EVENT GPIB
330 !
340 WRITE @SLM:"FQ",FREQ
350 WRITE @SLM:"MA24"!-----BW 3.1KHz & IMPULSE NOISE
360 WRITE @SLM:"DT",DTIME,"M"!- TIME SET
370 !
380 WRITE @SLM:"S1"!----- START LAMP ON
390 TRG @SLM!----- TRIGGER SLM
400 IF FLAG=1 THEN
410 WRITE @SLM:"TIL"!----- TALK COUNT
420 READ @SLM:COUNT
430 !
440 LET COUNT=COUNT*100
450 !
460 PRINT USING "COUNT #### FREQ #####.### KHz":LEVEL,FREQ
470 LET FLAG=0
480 ELSE
490 GO TO 400
500 END IF
510 END
520 REM-----
530 PARACT GPIBSRQ URGENCY 50
540 COM SLM,FLAG
550 WAIT EVENT GPIB
560 STATUS @SLM:A
570 TRG @SLM
580 LET FLAG=1
590 GO TO 550
600 END PARACT
```

Example 11

```

10 PRINTER IS 1
20 !*****
30 !***                                     ***
40 !*** ML422B - HP 9826                 ***
50 !***                                     ***
60 !*** INTERRUPT                       ***
70 !***                                     ***
80 !*****
90 INPUT "LOOP=?",Loop
100 ! ---- INITIALIZE ----
110 DIM Data$(1000)[20]
120     S1m=700 ; device address S1M=0
130     S1a=704 ; device address S1G=4
140     Lprinter=717 ; device address printer=17
150 !-----
160 !SLM INITIALIZE
170 REMOTE S1m ; Remote control for S1M
180 OUTPUT S1m:"SR1" ; Service request after
190 ! INTERRUPT SET ; SLM measurement ends
200 S=SPOLL(S1m) ; Serial poll
210 ON INTR 7 GOSUB Interrupt
220 Mask=2
230 ENABLE INTR 7:Mask
240 !-----
250 TRIGGER S1m
260 FOR I=0 TO Loop-1
270 IF Flag=1 THEN
280     OUTPUT S1m:"TIL" ; Identification of SLM
290     ENTER S1m:Data$(I) ; OUTPUT data
300     Flag=0 ; Readout of measurement
310 ELSE ; result
320     GOTO 270
330 END IF
340 !
350 PRINT "LU(dB): ";Data$(I) ; Printout of measurement
360 ! ; result
370 NEXT I
380 BEEP
390 STOP
400 Interrupt: ! ; Service request inter-
410     S=SPOLL(S1m) ; rupt routine
420     Flag=1
430     TRIGGER S1m ; Measurement start for
440     ENABLE INTR 7 ; SLM
450     RETURN
460     END

```

BITS					Column	0	1	2	3	4	5	6	7							
b ₄	b ₃	b ₂	b ₁	Row ↓	0	1	2	3	4	5	6	7								
0	0	0	0	0	NUL		DCE	SP	0	@	P	'	p							
0	0	0	1	1	SOH	GTL	DC1	LLO !	1	A	Q	a	q							
0	0	1	0	2	STX		DC2	"	2	B	R	b	r							
0	0	1	1	3	ETX		DC3	#	3	C	S	c	s							
0	1	0	0	4	EOT	SDC	DC4	DCL \$	4	D	T	d	t							
0	1	0	1	5	ENQ	PPC	NAK	PPU %	5	E	U	e	u							
0	1	1	0	6	ACK		SYN	&	6	F	V	f	v							
0	1	1	1	7	BEL		ETB	,	7	G	W	g	w							
1	0	0	0	8	BS	GET	CAN	SPE (8	H	X	h	x							
1	0	0	1	9	HT	TCT	EM	SPD)	9	I	Y	i	y							
1	0	1	0	10	LF		SUB	*	:	J	Z	j	z							
1	0	1	1	11	VT		ESC	+	;	K	[k	{							
1	1	0	0	12	FF		FS	,	<	L	/	l	:							
1	1	0	1	13	CR		GS	-	=	M]	m	}							
1	1	1	0	14	SO		RS	.	>	N	^	n	~							
1	1	1	1	15	S1		US	/	?	O	_	o	DEL							
					LISTEN address assigned to the device				TALK address assigned to the device				Has the meanings determined by PCG							
					ADDRESSED UNIVERSAL COMMAND GROUP				LISTEN ADDRESS GROUP				TALK ADDRESS GROUP				SECONDARY COMMAND GROUP (SCG)			

PRIMARY COMMAND GROUP (PCG)

NOTE 1: MSG stands for the abbreviation of an interface message, which is set out by ATN-"1".
 NOTE 2: b1 to b7 correspond to D101 to D107, respectively.

GP-IB Interface Message

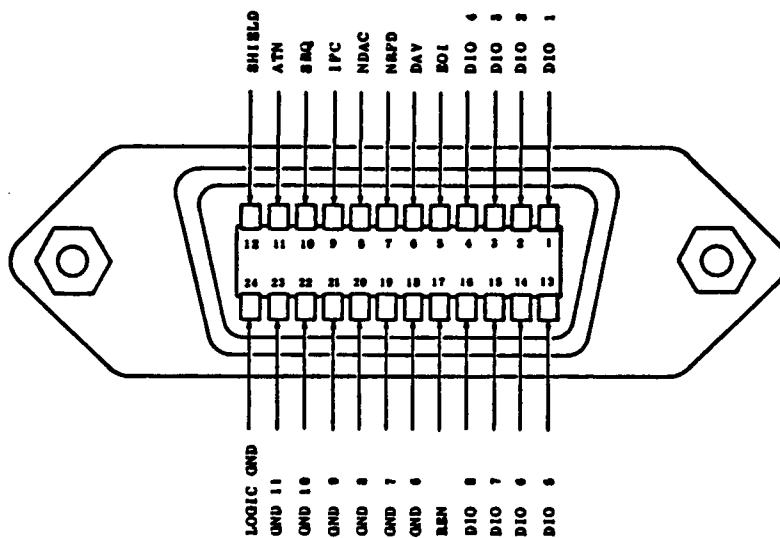

Fig. 6-2 GPIB Interface Connector Pin Arrangement

Tracking Operation

6.7 Tracking Operation

CASE 1: Tracking from the ML422B/C to the MG443B

STEP	PROCEDURE
1	Set the ADDRESS switch on the rear panel of the ML422B/C to TALK ONLY (TON).
2	Set the ADDRESS switch on the rear panel of the MG443B to LISTEN ONLY (LON).
3	Turn on the MG443B.
4	Turn on the ML422B/C.
5	Set STATUS on the MG443B to LON.
6	Set STATUS on the ML422B/C to TON.
7	Set the frequency of the ML422B/C.

CASE 2: Tracking from the MG443B to the ML422B/C

STEP	PROCEDURE
------	-----------

- 1 Set the ADDRESS switch on the rear panel of the ML422B/C to LISTEN ONLY (LON).

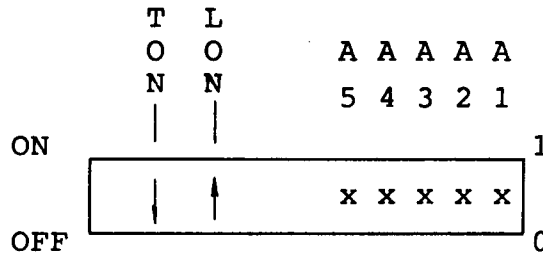

- 2 Set the ADDRESS switch on the rear panel of the MG443B to TALK ONLY (TON).

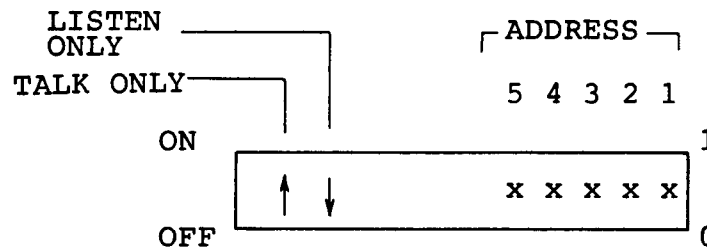

- 3 Turn on the ML422B/C.
- 4 Turn on the MG433B.
- 5 Set STATUS on the ML422B/C to LON.
- 6 Set STATUS on the MG443B to TON.
- 7 Modify the frequency of the MG443B.

Note: It is advisable to lock the ML422B/C to the reference frequency of the MG443B.

OPERATION MANUAL
SELECTIVE LEVEL METER
ML422 B/C

SUPPLEMENT
ON
FREQUENCY SETTING BASED ON
FDM CHANNEL PLAN AND
NPR MEASUREMENT

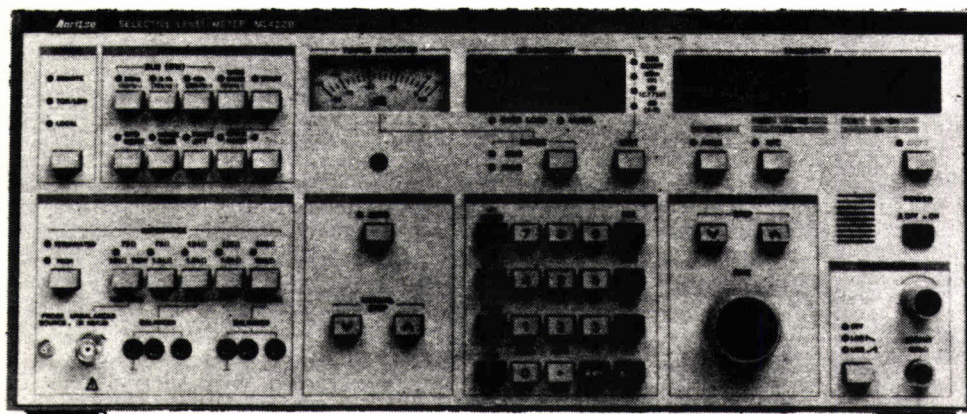

SUPPLEMENT
ON
FREQUENCY SETTING BASED ON
FDM CHANNEL PLAN
AND NPR MEASUREMENT

CERTIFICATION

ANRITSU CORPORATION certifies that this instrument has been thoroughly tested and inspected, and found to meet published specifications prior to shipping. Anritsu further certifies that its calibration measurements are based on the Japanese Electrotechnical Laboratory and Radio Research Laboratory standards.

WARRANTY

All parts of this product are warranted by Anritsu Corporation of Japan against defects in material or workmanship for a period of one year from the date of delivery. In the event of a defect occurring during the warranty period, Anritsu Corporation will repair or replace this product within a reasonable period of time after notification, free-of-charge, provided that: it is returned to Anritsu; has not been misused; has not been damaged by an act of God; and that the user has followed the instructions in the operation manual.

Any unauthorized modification, repair, or attempt to repair, will render this warranty void.

This warranty is effective only for the original purchaser of this product and is not transferable if it is resold.

ALL OTHER EXPRESSED WARRANTIES ARE DISCLAIMED AND ALL IMPLIED WARRANTIES FOR THIS PRODUCT, INCLUDING THE WARRANTIES OF MERCHANTABILITY AND FITNESS FOR A PARTICULAR PURPOSE, ARE LIMITED IN DURATION TO A PERIOD OF ONE YEAR FROM THE DATE OF DELIVERY. IN NO EVENT SHALL ANRITSU CORPORATION BE LIABLE TO THE CUSTOMER FOR ANY DAMAGES, INCLUDING LOST PROFITS, OR OTHER INCIDENTAL OR CONSEQUENTIAL DAMAGES, ARISING OUT OF THE USE OR INABILITY TO USE THIS PRODUCT.

All requests for repair or replacement under this warranty must be made as soon as possible after the defect has been noticed and must be directed to Anritsu Corporation or its representative in your area.

Copyright © 1985 by Anritsu Electric Co., Ltd. Printed in Japan.
All rights reserved. No part of this manual may be reproduced in any form without written permission of Anritsu Electric Co., Ltd.

Copyright © 1986 by ANRITSU CORP. Printed in Japan.
All rights reserved. No part of this manual may be reproduced in any form without written permission of ANRITSU CORP.

TABLE OF CONTENTS

	Page
SECTION 1 FDM CHANNEL PLAN FREQUENCY SETTING	1-1
1.1 General	1-1
1.2 FDM Plans in the ML422B/C	1-1
1.3 Basic Frequency	1-3
1.4 Panel Keys used in the FDM Plan Mode	1-5
1.5 FDM Plan Mode Setting	1-6
1.6 Signaling Tone, CH Center, and Group Center Frequency Settings	1-8
1.7 Pilot Frequency Setting	1-10
1.8 Changing the FDM Plan	1-14
1.9 Changing the Basic Frequency	1-15
CHAPTER 2 NPR MEASUREMENT MODE	2-1
2.1 General	2-1
2.2 NPR Mode Setting	2-3
2.3 NPR Measurement	2-4
2.4 Measurement Errors Caused by the Intrinsic NPR	2-6
2.5 NPR Measurement Error Calibration	2-8

SECTION 1

FDM CHANNEL PLAN FREQUENCY SETTING

1.1 General

The ML422B and ML422C have a built-in function for setting frequencies based on the BELL system and CCITT PLAN, respectively. When this function is used, time and labor are saved when setting frequencies using the frequency table.

1.2 FDM Plans in the ML422B/C

Four types of FDM plans (plans No. 1 to 4 shown in Table 1.2-1) are built into the ML422B/C. Frequencies for measuring the pilot level, signaling level, channel power, and group power based on these plans can be set.

Table 1.2-1 FDM Plans in the ML422B/C

Plan No.	FDM Channel Plan	Frequency Allocation	Turn on Condition
1	CCITT Rec. G332 Plan 1A, G334 Plan 1 G343 Plan 1	See Fig. 1.2-1	ML422C STD ML422B (OPT 41)
2	CCITT Rec. G332 Plan 2, G334 Plan 2 G343 Plan 1	See Fig. 1.2-2	OPT 43
3	Bell system MMX-2	See Fig. 1.2-3	ML422B STD ML422C (OPT 42)
4	CCITT Rec. G332 Plan 1A, G334 Plan 1 (Frequency setting using the SMG No.)	See Fig. 1.2-4	_____

Note: Fig. 1.2-1 to 1.2-4 are at the back of this manual.

When the power is turned on, the initial selection of an FDM plan is determined as shown in turn-on condition of Table 1.2-1, which differs depending on whether the ML422B/ML422C is a standard type or has options.

The FDM plan can be changed to another plan as explained in paragraph 1.8.

1.3 Basic Frequency

The basic frequencies for setting the pilots, signaling tone, and others are determined according to the FDM plans as shown in Table 1.3-1 when the power is turned on. These basic frequencies are the standard values for each FDM plan, but they can be changed if necessary as explained in paragraph 1.9.

Table 1.3-1 Basic Frequencies

Basic No.	Frequency (Kind)	Plan No.1	Plan No.2	Plan No.3	Plan No.4
0	_____	_____	_____	_____	_____
1	Signaling tone	3825 Hz	3825 Hz	2600 Hz	3825 Hz
2	CH center	1850 Hz	1850 Hz	1850 Hz	2850 Hz
3	G pilot	84.08 kHz	84.08 kHz	104.08 kHz	84.08 kHz
4	SG pilot	411.92 kHz	411.92 kHz	315.92 kHz	411.92 kHz
5	MG pilot	1552 kHz	1552 kHz	2840 kHz	1552 kHz
6	G center	84 kHz	84 kHz	84 kHz	84 kHz

CH; channel, G; Group, SG; supergroup, MG; mastergroup

The basic frequencies are defined as shown in Table 1.3-2.

Table 1.3-2 Definitions of Basic Frequencies

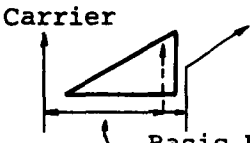
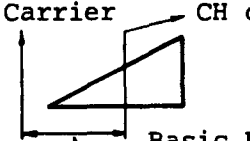
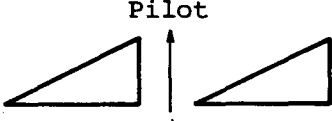
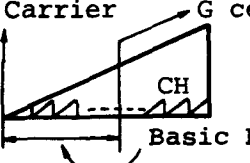
Basic Frequency	Definition
Signalling tone	 <p data-bbox="586 709 1347 768">Basic Frequency = carrier freq. - signaling tone freq. </p>
CH center	 <p data-bbox="586 968 1347 1026">Basic Frequency = carrier freq. - CH center freq. </p>
Pilot	 <p data-bbox="586 1226 1195 1251">Basic Frequency = basic pilot freq.</p>
G center	 <p data-bbox="586 1451 1347 1509">Basic Frequency = carrier freq. - G center freq. </p>

1.4 Panel Keys used in the FDM Plan Mode

When the [SHIFT] key is pressed, the "DATA ENTRY" key functions are shifted as shown in the following table and used in the FDM plan mode.

Table 1.4-1

<u>SHIFT (OFF)</u>		<u>SHIFT (ON)</u>	<u>Explanation</u>
[FREQ]	→	[MG]	Selects the mastergroup (MG). In plan No. 4, pressing this key alternately switches the MG and supermastergroup (SMG).
[STEP FREQ]	→	[SG]	Selects the supergroup.
[FULL SCALE]	→	[G]	Selects the group.
[REF(R)]	→	[CH]	Selects the channel.
[.]	→	[PILOT]	Selects the pilot frequency. Press this key after pressing the [CH], [G], and [SG] keys. " f_p " is then displayed in the MEASUREMENT display.
[MHz -dB]	→	[P.ENT]	Sets the frequency corresponding to the data set by the FDM description (CH, G---).
[0]	→	[CLEAR]	Clears the value set previously or " f_p ". In addition, this key can be used as [0] (zero) key for inputting a numeric value.

1.5 FDM Plan Mode Setting

When the [MG], [SG], [G], or [CH] key is pressed after pressing the [SHIFT] key, an FDM plan mode is set. The FREQUENCY display section displays as shown in the following examples. The point (.) in the position corresponding to the label of the pressed key blinks.

Plan No. 1 to 3

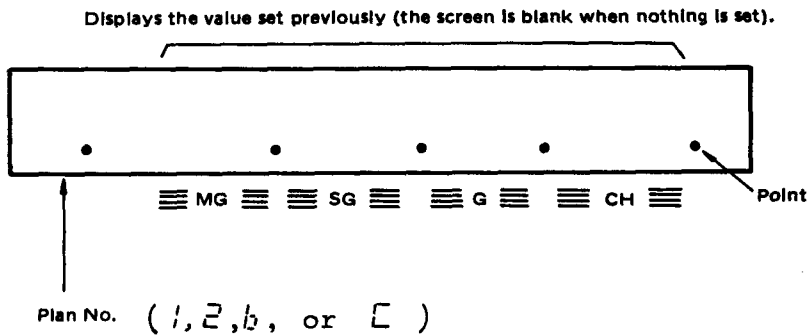

Plan No. 4

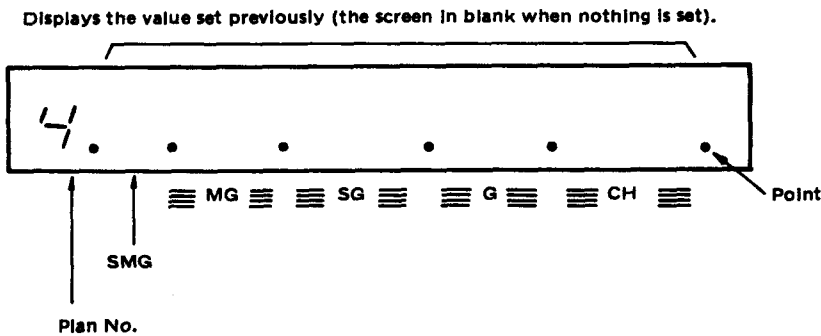

The displays for the plan numbers in the above examples differ depending on the ML422B/C model and the models with OPT 41 to OPT 43. The displays are shown in the following table.

Table 1.5-1 Plan No. Indication

Model	Plan No.	Indication
	1	[
ML422B standard & ML422C with OPT 42	2	2
	3	b ; Turn on condition
	4	4

	1	[; Turn on condition
ML422C standard & ML422B with OPT 41	2	2
	3	b
	4	4

	1	1
ML422C with OPT 43	2	[; Turn on condition
	3	b
	4	4

[; CCITT plan C

b ; Bell plan B

1.6 Signaling Tone, CH Center, and Group Center Frequency Settings

When these frequencies are set, the bandwidth (BW), as shown in the following table, must be set beforehand in accordance with the frequency use.

When the BW is set, the frequency corresponding to its use is automatically selected.

Table 1.6-1 Relationship Between BW and Selected Frequency

Bandwidth (BW)	Selected frequency	Use
20 Hz	Signaling tone	Signaling level measurement
3.1 kHz	CH center	CH power and idle noise measurements
48 kHz	Group center	Group power and idle noise measurements

The operating procedures for setting these frequencies based on the FDM channel plan are explained in Table 1.6-2 with plan No. 1 as an example.

Basically, the procedures for the other plans are the same, but since the FDM distribution expression differs with each plan, operations should be done by referring to the contents shown in Figs. 1.2-1 to 1.2-4.

Table 1.6-2 Frequency Setting Using Plan No. 1

STEP	PROCEDURE
1	<p>Set the bandwidth.</p> <p>BW 20 Hz (Signaling tone) ----- Signaling level measurement BW 3.1 kHz (CH center) ----- CH power and idle noise measurements BW 48 kHz (Group center) ----- Group power and idle noise measurements</p>
2	<p>Press [SHIFT]. (SHIFT ON)</p>
3	<p>Press [MG] ... When this key is pressed in plan No. 4, the key function alternately changes between SMG and MG. After setting SGM No. (1 to 4), set MG No.</p>
4	<p>Input a numeric value or press [CLEAR].</p> <p>1, 2 or 3 (SMG 1) 4, 5 or 6 (SMG 2) 7, 8 or 9 (SMG 3 or Basic Supermastergroup) --- At plan No. 4, these MG No's. only are used. 10, 11 or 12 (SMG 4)</p> <p>When [CLEAR] is pressed, the screen remains blank.</p>
5	<p>Press [SG].</p>
6	<p>Input a numeric value or press [CLEAR]</p> <p>4 to 8 (Basic mastergroup) or (SG No.) 1 to 16 (SG1 + 15 supergroup assembly)</p> <p>When [CLEAR] is pressed, the screen remains blank.</p>
7	<p>Press [G].</p>
8	<p>Input a numeric value or press [CLEAR].</p> <p>1 to 5 (Basic supergroup) or (G No.)</p> <p>When [CLEAR] is pressed, the screen remain blank.</p>

Table 1.6-2 Continued

STEP	PROCEDURE
9	Press [CH].
10	Input a numeric value. 1 to 12 (Basic group) or (CH No.)
11	Press [P.ENT]. *1 When this key is pressed, the frequency is set, and the mode is automatically switched to the measurement mode.

* If an incorrect channel plan combination or value is input, "CP Error" is displayed. Input the correct value.

When these procedures are completed, the demodulator is automatically set to USB or LSB in accordance with the FDM hierarchy in use.

1.7 Pilot Frequency Setting

The basic pilot frequencies of group (G), supergroup (SG), and mastergroup (MG) are determined as shown in Table 1.3-1 for each plan. The pilot frequencies are shown in Figs. 1.2-1 to 1.2-4.

The basic pilot frequency or the pilot frequency at each conversion step is set according to the following procedures.

Group Pilot Setting

STEP	PROCEDURE	
1	Set the bandwidth. BW 20 Hz, 3.1 kHz, or (48 kHz)	The pilot frequency can be set regardless of the BW selection, but normally it is set to 20 Hz.
2	Press [SHIFT].	
3	Press [MG].	For G pilot setting in MG (No.), start from this step.
4	Input a numeric value. Or press [CLEAR].	When no setting is required, press [CLEAR] after Step 3 and leave the screen blank.
5	Press [SG].	For G pilot setting in SG (No.), start from this step.
6	Input a numeric value. Or press [CLEAR].	When no setting is required, press [CLEAR] after Step 5 and leave the screen blank.
7	Press [G].	For G pilot setting in G (No.), start from this step.
8	Input a numeric value. Or Press CLEAR.	When no setting is required, press [CLEAR] after Step 7 and leave the screen blank.
9	Press [CH].	For basic group pilot setting, start from this step.
10	Press [PILOT].	When this key is pressed, "P" is displayed indicating that pilot has been input.
11	Press [P.ENT]. *1	When this key is pressed, the pilot frequency is set, and the mode is automatically switched to the measurement mode.

* If an incorrect channel plan combination or value is input

"CP Error" is displayed. Input the correct value.

Supergroup Pilot Setting

STEP	PROCEDURE	
1	Set the bandwidth. BW 20 Hz, 3.1 kHz or (48 kHz)	The pilot frequency can be set regardless of the BW selection, but normally is set to 20 Hz.
2	Press [SHIFT]. (SHIFT ON)	
3	Press [MG].	For SG pilot setting in MG (No.), start from this step.
4	Input a numeric value. Or Press [CLEAR]	When no setting is required, press [CLEAR] after Step 3 and leave the screen blank.

5	Press [SG].	For SG pilot setting in SG (No.), start from this step.
6	Input a numeric value. Or press [CLEAR].	When no setting is required, press [CLEAR] after Step 5 and leave the screen blank.

7	Press [G].	For a basic supergroup pilot setting, start from this step.
8	Press [PILOT].	When this key is pressed, "P" is displayed indicating that pilot has been input.

9	Press [CH].	This step may be deleted if nothing is displayed.
10	Press [CLEAR].	

11	Press [P.ENT]. *1	When this key is pressed, the pilot frequency is set, and the mode is automatically set to the measurement mode.

* If an incorrect channel plan combination or value is input

"CP Error" is displayed. Input the correct value.

Mastergroup Pilot Setting

STEP	PROCEDURE	
1	Set the bandwidth. BW 20 Hz, 3.1 kHz or (48 kHz)	The pilot frequency can be set regardless of the BW selection, but normally it is set to 20 Hz.
2	Press [SHIFT]. (SHIFT ON)	

3	Press [MG].	For MG pilot setting in MG (No.), start from this step.
4	Input a numeric value. Or Press [CLEAR]	When no setting is required, press [CLEAR] after Step 3 and leave the screen blank.

5	Press [SG].	For a basic mastergroup pilot setting, start from this step.
6	Press [PILOT]	When this key is pressed, " " is displayed indicating that pilot has been input.

7	Press [G].	This step may be deleted if nothing is displayed.
8	Press [CLEAR].	

9	Press [CH].	This step may be deleted if nothing is displayed.
10	Press [CLEAR].	

11	Press [P.ENT]. *1	When this key is pressed, the pilot frequency is set, and the mode is automatically set to the measurement mode.

* If an incorrect channel plan combination or value is input
 "CP Error" is displayed. Input the correct value.

1.8 Changing an FDM Plan

An FDM plan specified when the power is turned on can be changed to another plan by the following procedures.

STEP	PROCEDURE
1	Press [SHIFT]. (SHIFT ON)
2.	Press the [MG], [SG], [G], or [CH] key (hereinafter referred to as the CP keys). Then "." is displayed at the "FREQUENCY display plan number section of the ML422B STD type, or "[" is displayed at the ML422C STD type, in the turned on condition.

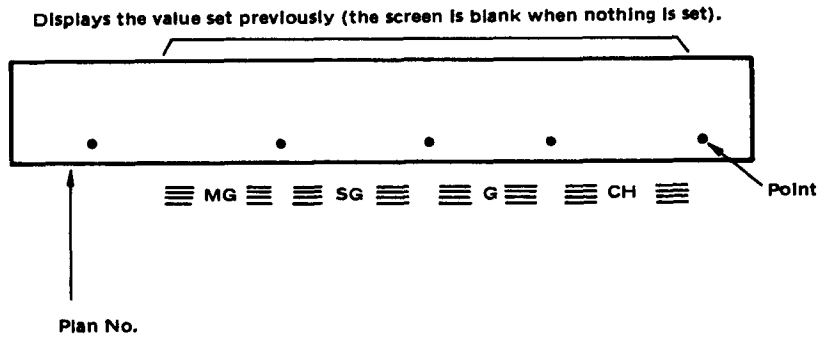

The point (.) in the position corresponding to the label of the pressed CP key blinks.

3. Press [STATUS].
The point (.) in the plan number section blinks and the FDM plan can be changed.
4. Use the ten-key pad to input the plan number corresponding to the desired FDM plan to be changed to.

The plan changed by this operation returns to the turn on condition shown in Table 1.2-1 when the power is turned on again.

[GPIB command: "CKn" n; Plan No. (1 to 4)]

1.9 Changing the Basic Frequency

The standard basic frequencies of the FDM plans can be changed by using the following procedures.

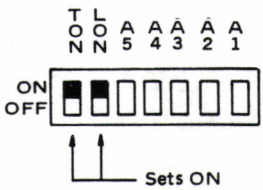
STEP	PROCEDURE
1	Turn on the GP-IB switches "TON" and "LON" on the rear panel. 
2.	Press [RECALL]. (SHIFT OFF) The "MEASUREMENT" display section displays " REC".
3.	Input a numeric value. (See Table 1.3-1.) Two-digit values of 11,12,--45, and 46 For example, when changing the plan No. 1 group pilot frequency, set in sequence of [1], and [3].
4.	Press [.] *1 In the example in Step 3, " REC.13 " is displayed at the "MEASUREMENT" display section and "84080 " (84080, initial data) at the "FREQUENCY" display section.
5.	Input the frequency value.
6.	Press [Hz], [kHz], or [MHz]. When this key is pressed, the basic frequency is changed and the mode is automatically switched to the measurement mode.

STEP	PROCEDURE
7	<p>Turn off the GP-IB switches "TON" and "LON" on the rear panel.</p> <p>This step may be deleted when the [RECALL] (including [MEMORY]) key is not used.</p>

Note: The basic frequency changed by this operation returns to the standard value shown in Table 1.3-1 when the power is turned on again.

*1 If an incorrect numeric value is input, " r E C O F " or " F F F F F F F F " is displayed at the "MEASUREMENT" or "FREQUENCY" display section. Then, reset from Step 2. As long as the last point in the " r E [.** ." is not displayed, input of the numeric value can be continued.

[GPIB command: "Cn₁n₂" n1: Basic No. (1 to 6)
n2: Frequency (e.g. 3850
= 3850 Hz)]

SECTION 2

NPR MEASUREMENT MODE

2.1 General

The best way to evaluate the performance of the FDM telephony is to evaluate it under conditions as close as possible to the actual operation.

Since the multiplex signal characteristic is similar to the white noise that is uniformly distributed in the occupied frequency band, CCITT recommends that white noise be used instead of the multiple signal to evaluate system performance.

The noise power ratio (NPR*) measurement is one of the methods to evaluate system performance.

The ML422B/C is provided with an NPR measurement mode. The system NPR can be measured in combination with a noise generator.

* NPR Measurement Principle:

White noise having the same bandwidth as the occupied frequency bandwidth of the system is added from a noise generator and, with a noise meter, the noise level (N_c) of one channel (center frequency f_c) is measured. Then a band stop filter (BSF, center frequency f_c) is inserted at the output of the noise generator, and a noise signal free of the channel noise is added to the system. The noise level (N_d) in this condition is again measured with a noise meter.

The NPR value can be obtained from $N_c - N_d$ (dB).
 In an ideal system, N_d cannot be measured with a noise meter. However, in actuality, a limited value is measured because of the non-linear and thermal noises in the line.

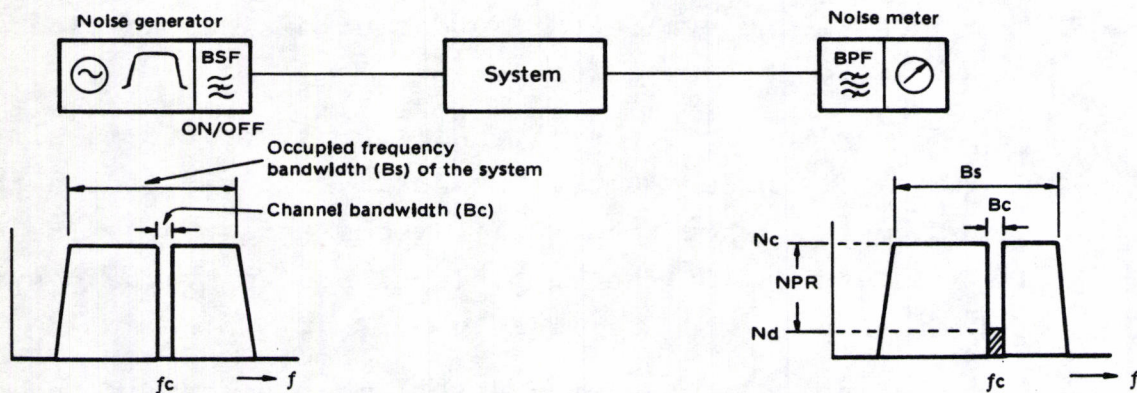
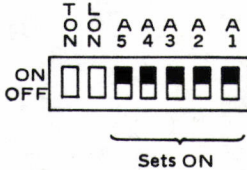

Fig. 2.1-1 NPR Measurement Principle

2.2 NPR Mode Setting

The NPR mode is set by the following procedures. Then, the level is controlled so that the NPR of the ML422B/C itself (intrinsic NPR) is kept to a minimum.

STEP	PROCEDURE
1	Turn on all GP-IB ADDRESS switches on the rear panel. 
2.	Set "BW" to 3.1 kHz. BW 48 kHz will operate for NPR mode, but BW 20 Hz will not.
3.	Set "RANGE" to 100 dB.
4.	Set "FULL SCALE" to AUTO (Auto landing).
5.	Turn on "AVRG"-- Improves the uniformity of the measured values.

NPR mode can be set from the GP-IB by issuing the following commands from the controller.

"NP1" ... NPR mode (NPO = normal mode)
"MA2" ... BW 3.1 kHz
"RG2" ... 100 dB range
"FS1" ... Auto ranging
("AV1" ... Average ON)

2.3 NPR Measurement

Connect the ML422B/C and a noise generator to the system as shown in the figure below. CCITT recommends a noise generator equipped with a standardized occupied frequency band filter and a band-stop filter (BSF) in accordance with the number of channels in the system under test. (The Anritsu model available is the MG431A.)

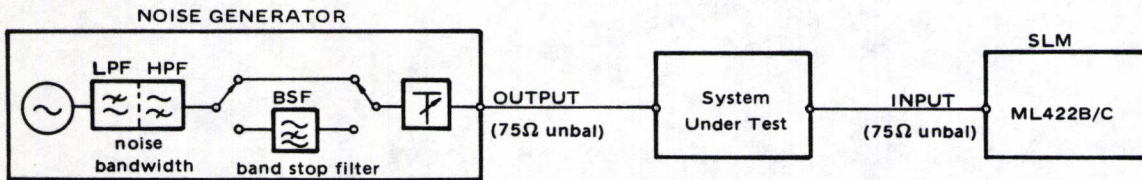

Fig. 2.3-1 NPR Measurement with the ML422B/C

The NPR measurement procedures are as follows.

STEP	PROCEDURE
1	Set the output level for the system under test by selecting the noise generator bandwidth and BSF.
2.	Set NPR mode. See paragraph 2.2.
3.	Set the measuring frequency to the BSF center frequency and measure.
4.	* Press the [UNIT] key and set to "dB". (X-R) Reference value is the measured value in step 3.
5.	* Press the [REF(R)] key.
6.	* Press the [MEMORY] key.
7.	Insert the BSF in to the noise generator. The measured value obtained is the NPR value.

* Steps 4 to 6 may be deleted, in which case the NPR value is the difference between the measured values in Steps 3 and 7.

2.4 Measurement Errors Caused by the Intrinsic NPR

When the system NPR is measured, the measured result is worse than the real NPR value because of the error of the ML422B/C intrinsic NPR. The measurement error increases as the measured NPR value nears the intrinsic NPR value.

Therefore, to obtain the real NPR value, the ML422B/C intrinsic NPR must be measured and calibrated according to the procedures described in paragraph 2.5.

The typical ML422B/C intrinsic NPR values in each noise bandwidth and total power level are shown in Table 2.4-1.

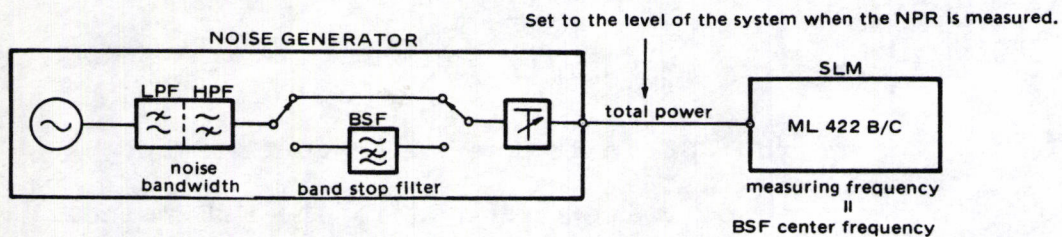

$$\text{Intrinsic NPR} = P_c - P_d \text{ (dB)}$$

P_c : SLM reading without BSF

P_d : SLM reading with BSF

Fig. 2.4-1 Intrinsic NPR measurement

Table 2.4-1 Intrinsic NPR (Typical Value)

Noise Bandwidth	60 to 1296 kHz (300 CH)	60 to 4100 kHz (960 CH)	316 to 12360 kHz (2700 CH)
Measuring Frequency	270 kHz	3886 kHz	3886 kHz
Total power Level (dBm)	NPR (dB)	NPR (dB)	NPR (dB)
+10	55.7	52.8	48.7
+ 5	56.4	54.1	50.4
0	55.8	54.0	50.6
- 5	55.9	54.0	50.2
-10	55.3	53.3	49.6
-15	56.2	54.0	50.7
-20	56.1	54.1	50.5
-25	56.1	54.1	50.2
-30	55.8	53.5	49.5

When the system NPR is measured under conditions other than those shown above, measure the ML422B/C intrinsic NPR under the same conditions except the noise bandwidth and the total power level conditions.

2.5 NPR Measurement Error Calibration

The real NPR value of the system is obtained using the following formula.

Real NPR value = NPR measured value + calibration value.

The calibration value is obtained from the graph in Fig. 2.5-1 based on the difference between the intrinsic and measured NPR values.

For example, when the intrinsic NPR is 54 dB and the measured NPR is 50 dB, the difference is 4 dB and, based on this value, the calibration value of 2.2 dB is obtained from the graph.

The real NPR value is then

"50 + 2.2 = 52.2 dB".

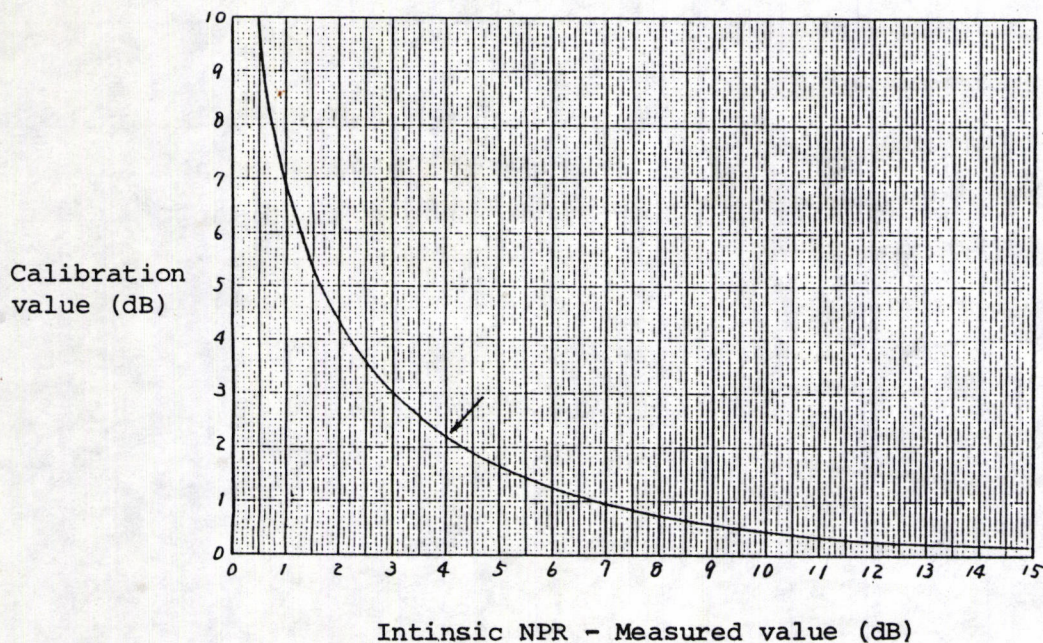
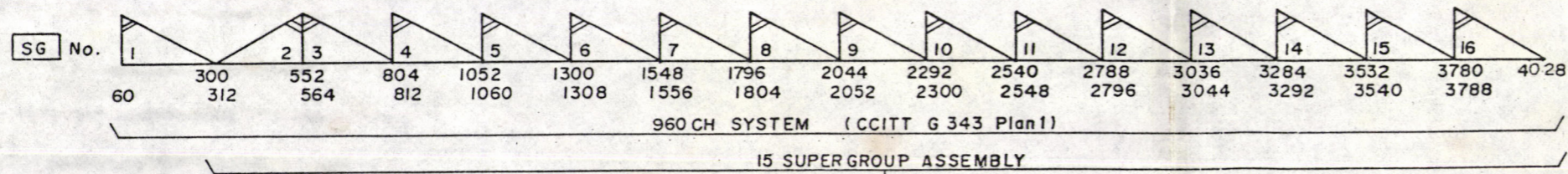
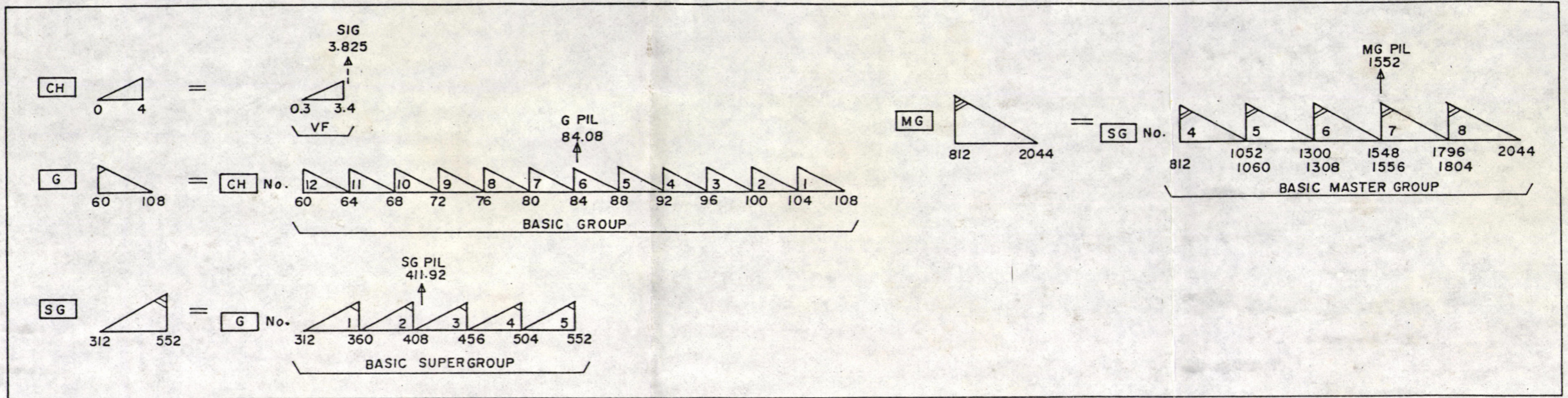
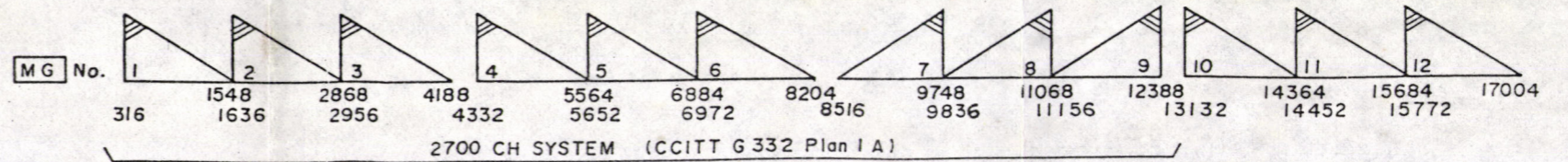

Fig. 2.5-1 Calibration of Measurement Errors Caused by the Intrinsic NPR

Fig.1.2-1 Frequency Allocation (CCITT G 332 Plan 1A/1B)



15 SUPERGROUP ASSEMBLY



3600 CH SYSTEM (CCITT G 334 Plan 1)

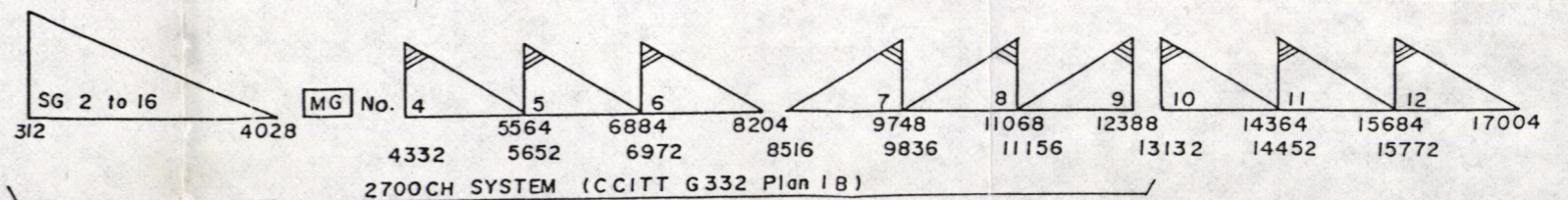

3600 CH SYSTEM

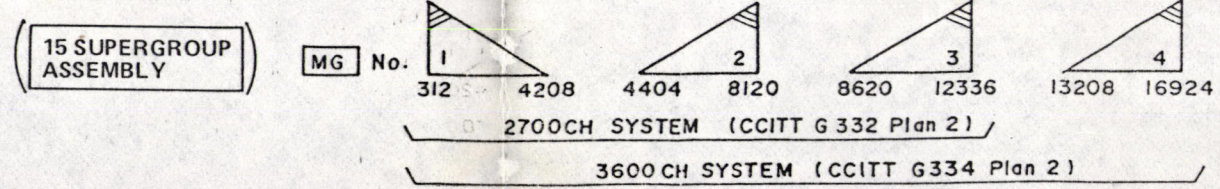
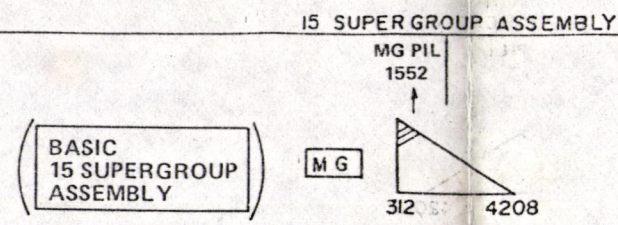
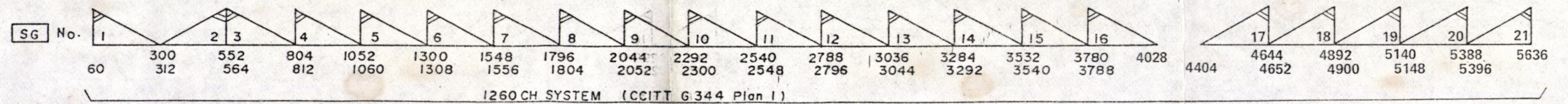
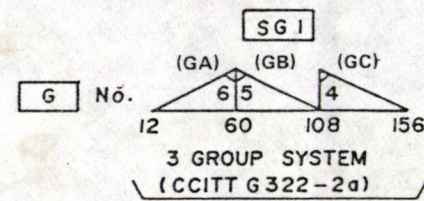
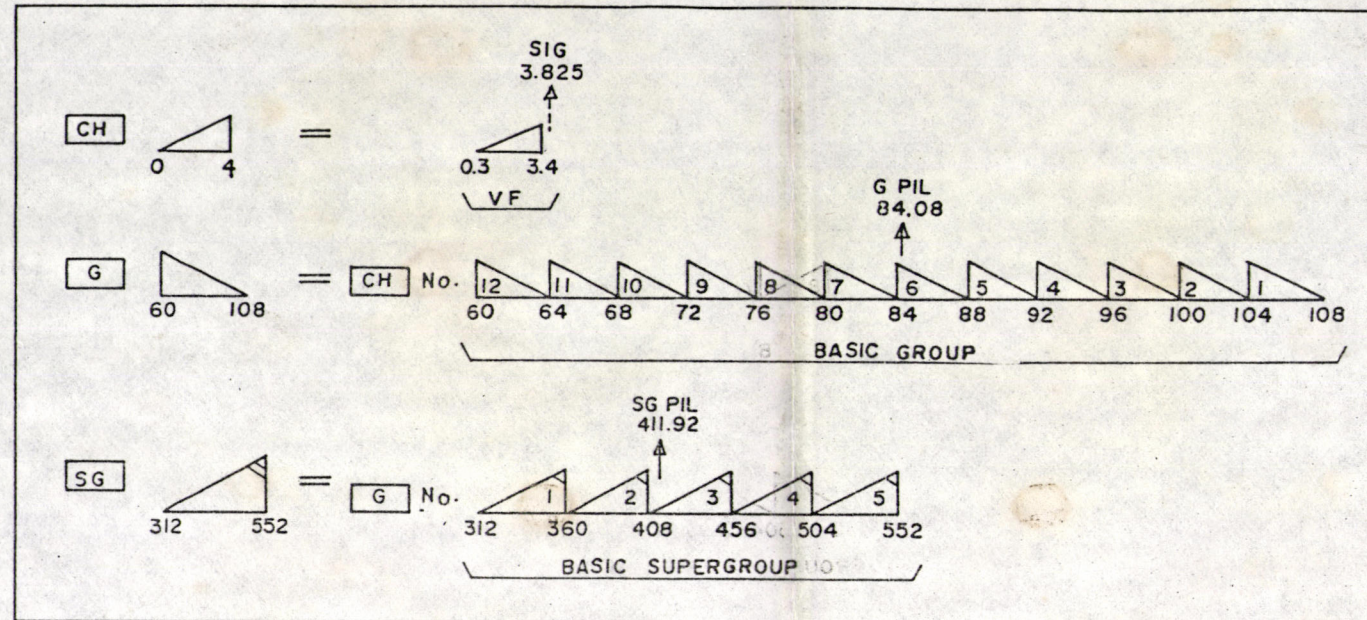
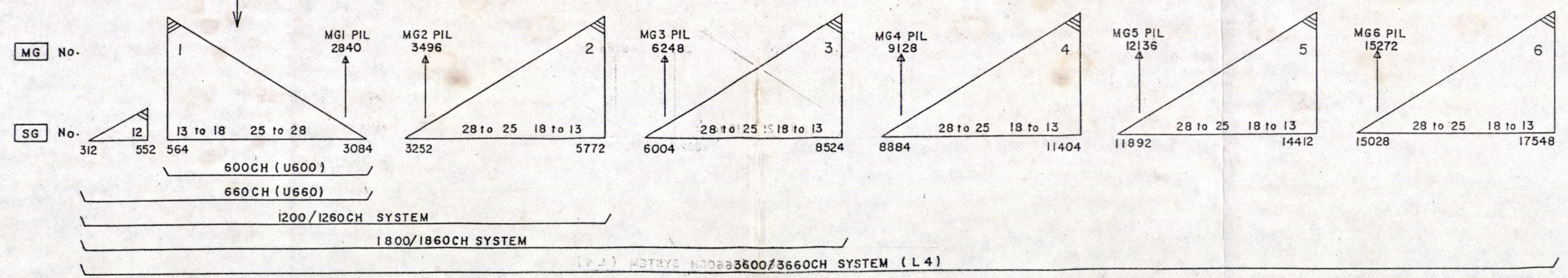
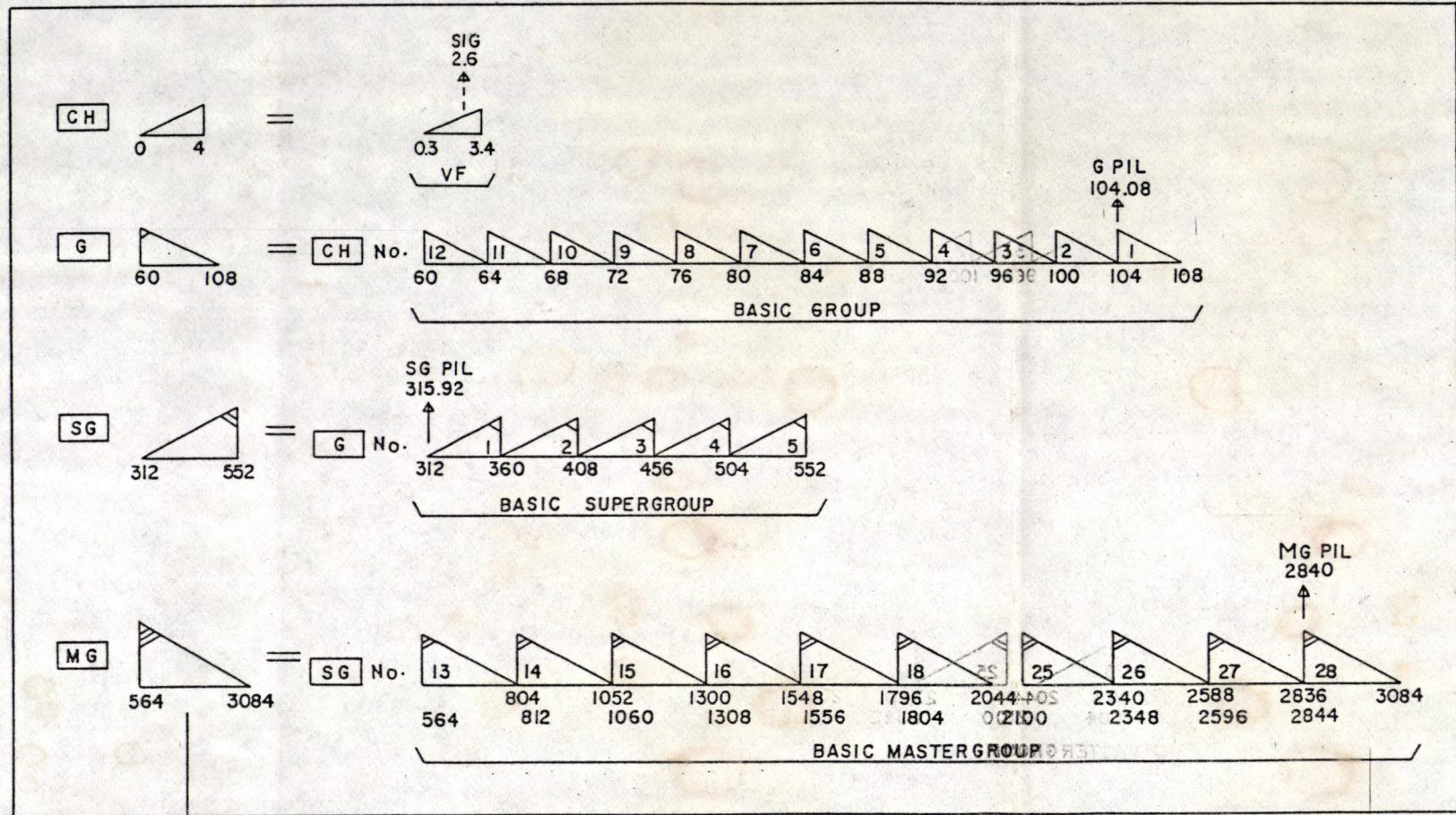
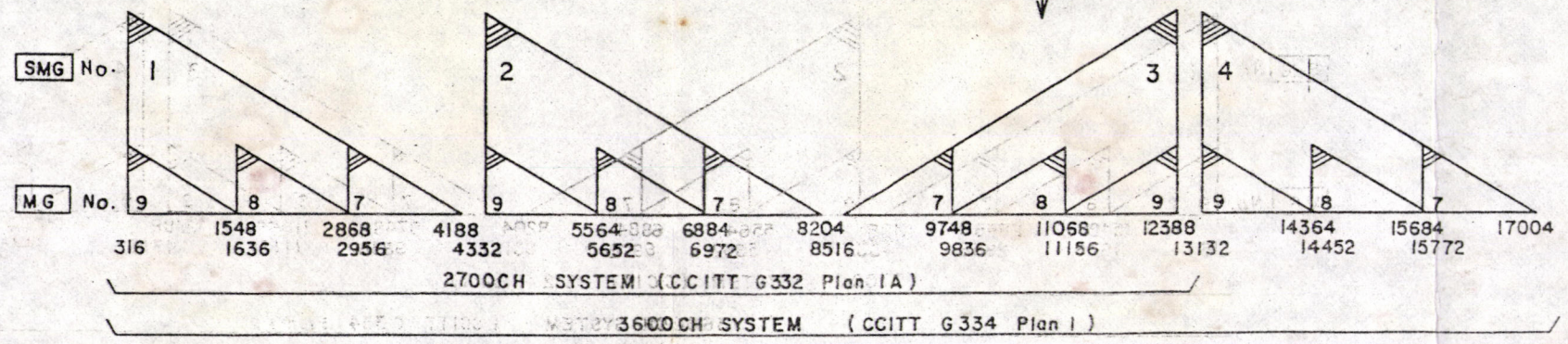
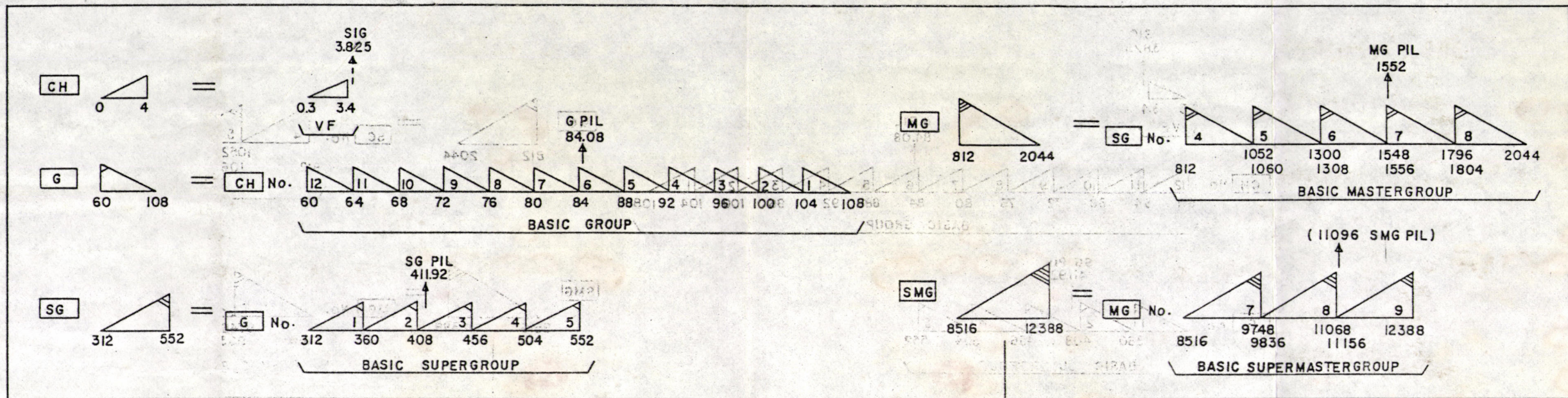
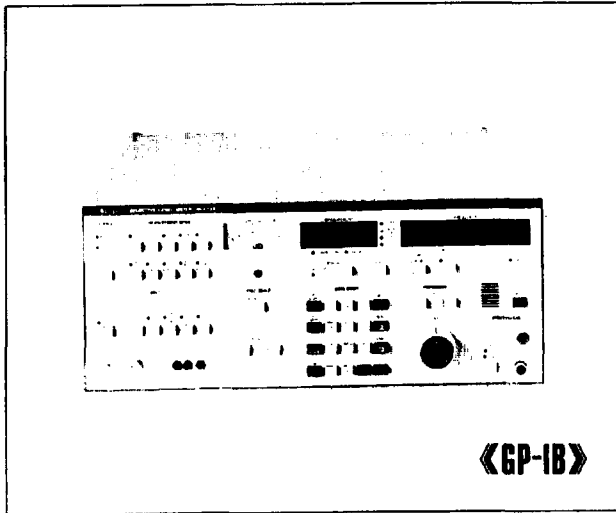

Fig.1.2-3 Frequency Allocation (Bell System MMX-2)





SELECTIVE LEVEL METER ML422B/C 50Hz to 30MHz



The ML422B and the ML422C are selective level meters. The ML422B is designed for use with Bell System FDM hierarchy, while the ML422C is for use with a CCITT system. Each instrument covers an extremely wide frequency range, from 50 Hz to 30 MHz. These remarkable instruments offer highly accurate measurement of signal levels, and they have the frequency accuracy and stability needed to manufacture and maintain FDM systems, from voice frequencies up to 3600 channels. The ML422B or ML422C can also function as a wideband level meter, psophometer, or voice band analyzer.

Features

- **Highly accurate level measurement**
Measures levels to an accuracy of ± 0.1 dB ($23^{\circ}\text{C} \pm 5^{\circ}$). Automatic level calibration ensures the accuracy needed for manufacture, installation and maintenance of FDM transmission lines and equipment.
- **Measurement of transmission impairment**
Fast troubleshooting of voice channel problems.
- **48 kHz group filter**
Easy testing of data transmission systems.
- **Intrinsic distortion below -70 dB**
Measures low noise levels under conditions of high interference.
- **True RMS value detection and 3.1 kHz bandwidth**
Measures psophometric weighted channel noise, without conversion, using the weighted 3.1 kHz BW.
- **Built-in microprocessor for simple operation**
Controls are simple, yet extensive: Autoranging, relative level measurement, hot tone search, direct frequency selection with 10-key pad, fine tuning dial, fixed interval frequency shifts with STEP key, and memory capacity for up to 20 different frequencies.
- **GP-IB compatibility for automatic measurement**
All functions except power switch and demodulator volume can be controlled through GP-IB (IEEE-standard 488-1978).

Specifications

Frequency range	50 Hz to 30 MHz (BW 20 Hz, WIDEBAND) 10 kHz to 30 MHz (BW 3.1 kHz) 36 kHz to 30 MHz (BW 48 kHz) 2 kHz to 2 MHz (75 Ω , 124 Ω , 150 Ω BALANCED INPUT) 50 Hz to 120 kHz (600 Ω BALANCED INPUT)
Frequency display	LED, 8 digits (minimum step: 1 Hz)
Reference frequency stability	$\leq 5 \times 10^{-7}/0^{\circ} \sim 45^{\circ}\text{C}$, $\leq 1 \times 10^{-6}/\text{year}$ (aging rate)
Level measuring range	-120 to +30 dBm (BW 20 Hz, ≥ 200 Hz) -100 to +30 dBm (BW 3.1 kHz) -80 to +30 dBm (BW 48 kHz) -60 to +30 dBm (WIDEBAND)
Noise floor	≤ -115 dBm (BW 3.1 kHz, 75 Ω UNBALANCED, full scale ≤ -30 dBm)

Continued on next page

Level measuring accuracy (1) 75Ω unbalanced	20dB scale range, AFC (ON), SCALE (AUTO)																																																
	<ul style="list-style-type: none"> ● Selective <table border="1"> <thead> <tr> <th>Temperature</th> <th>23°C ±5°</th> <th colspan="3">0° to 45° C</th> </tr> </thead> <tbody> <tr> <td>Frequency range</td> <td>10 kHz to 13 MHz</td> <td>50 Hz to 200 Hz</td> <td>200 Hz to 13 MHz</td> <td>13 MHz to 30 MHz</td> </tr> <tr> <td>Level range</td> <td></td> <td></td> <td></td> <td></td> </tr> <tr> <td>0 to +20 dBm</td> <td>±0.15 dB</td> <td>±0.2 dB</td> <td>±0.15 dB</td> <td>±0.2 dB</td> </tr> <tr> <td>-80 to 0 dBm</td> <td>±0.1 dB</td> <td></td> <td></td> <td></td> </tr> <tr> <td>-100 to -80 dBm</td> <td>±0.3 dB</td> <td>±1 dB</td> <td>±0.5 dB</td> <td>±0.5 dB</td> </tr> <tr> <td>-110 to -100 dBm</td> <td>±1 dB</td> <td>-</td> <td>±1.5 dB</td> <td>±1.5 dB</td> </tr> </tbody> </table> <ul style="list-style-type: none"> ● Wideband <table border="1"> <thead> <tr> <th>Frequency range</th> <th>200 Hz to 13 MHz</th> <th>13 MHz to 30 MHz</th> </tr> </thead> <tbody> <tr> <td>Level range</td> <td></td> <td></td> </tr> <tr> <td>-50 to +20 dBm</td> <td>±0.3 dB</td> <td>±0.5 dB</td> </tr> <tr> <td>-60 to -50 dBm</td> <td>±0.4 dB</td> <td>±0.6 dB</td> </tr> </tbody> </table> <p>(Note: Warming-up time, 30 minutes)</p>			Temperature	23°C ±5°	0° to 45° C			Frequency range	10 kHz to 13 MHz	50 Hz to 200 Hz	200 Hz to 13 MHz	13 MHz to 30 MHz	Level range					0 to +20 dBm	±0.15 dB	±0.2 dB	±0.15 dB	±0.2 dB	-80 to 0 dBm	±0.1 dB				-100 to -80 dBm	±0.3 dB	±1 dB	±0.5 dB	±0.5 dB	-110 to -100 dBm	±1 dB	-	±1.5 dB	±1.5 dB	Frequency range	200 Hz to 13 MHz	13 MHz to 30 MHz	Level range			-50 to +20 dBm	±0.3 dB	±0.5 dB	-60 to -50 dBm	±0.4 dB
Temperature	23°C ±5°	0° to 45° C																																															
Frequency range	10 kHz to 13 MHz	50 Hz to 200 Hz	200 Hz to 13 MHz	13 MHz to 30 MHz																																													
Level range																																																	
0 to +20 dBm	±0.15 dB	±0.2 dB	±0.15 dB	±0.2 dB																																													
-80 to 0 dBm	±0.1 dB																																																
-100 to -80 dBm	±0.3 dB	±1 dB	±0.5 dB	±0.5 dB																																													
-110 to -100 dBm	±1 dB	-	±1.5 dB	±1.5 dB																																													
Frequency range	200 Hz to 13 MHz	13 MHz to 30 MHz																																															
Level range																																																	
-50 to +20 dBm	±0.3 dB	±0.5 dB																																															
-60 to -50 dBm	±0.4 dB	±0.6 dB																																															
(2) Balanced	Add ±0.1 dB to the above accuracy																																																
Level display	LED 5 digits, resolution: 0.01 dB (20dB scale range) 0.1 dB (100dB scale range) Units: dBm, dB (0.775V), dB (X-R, relative to REF (R))																																																
Input impedance	<p>(1) Unbalanced input (75Ω) TERMINATED: Return loss ≥ 35 dB (50 Hz to 20 MHz) ≥ 25 dB (20 MHz to 30 MHz) HIGH: 10 kΩ ± 10% shunted by ≤ 80 pF</p> <p>(2) Balanced input TERMINATED: Return loss ≥ 30 dB CMRR ≥ 30 dB HIGH: 75Ω, 124Ω, 150Ω, *1 Typically 2 kΩ at 2 MHz 600Ω. Typically 15 kΩ at 120 kHz</p>																																																
Bandwidth and selectivity	<table border="1"> <thead> <tr> <th>Bandwidth</th> <th>Pass bandwidth</th> <th>Attenuation characteristic</th> </tr> </thead> <tbody> <tr> <td>20 Hz</td> <td>≥ 6 Hz (0.5 dB) 16 Hz ± 20% (3 dB)</td> <td>Within ± 35 Hz (45 dB) Within ± 70 Hz (60 dB) Within ± 2 kHz (80 dB)</td> </tr> <tr> <td>3.1 kHz</td> <td>≥ 1 kHz (0.5 dB) 3.1 kHz ± 10% (3 dB)</td> <td>Within ± 1.85 kHz (60 dB) Within ± 2.4 kHz (70 dB)</td> </tr> <tr> <td>48 kHz</td> <td>≥ 30 kHz (0.7 dB) 48 kHz ± 10% (3 dB)</td> <td>Within ± 36 kHz (60 dB)</td> </tr> </tbody> </table>			Bandwidth	Pass bandwidth	Attenuation characteristic	20 Hz	≥ 6 Hz (0.5 dB) 16 Hz ± 20% (3 dB)	Within ± 35 Hz (45 dB) Within ± 70 Hz (60 dB) Within ± 2 kHz (80 dB)	3.1 kHz	≥ 1 kHz (0.5 dB) 3.1 kHz ± 10% (3 dB)	Within ± 1.85 kHz (60 dB) Within ± 2.4 kHz (70 dB)	48 kHz	≥ 30 kHz (0.7 dB) 48 kHz ± 10% (3 dB)	Within ± 36 kHz (60 dB)																																		
Bandwidth	Pass bandwidth	Attenuation characteristic																																															
20 Hz	≥ 6 Hz (0.5 dB) 16 Hz ± 20% (3 dB)	Within ± 35 Hz (45 dB) Within ± 70 Hz (60 dB) Within ± 2 kHz (80 dB)																																															
3.1 kHz	≥ 1 kHz (0.5 dB) 3.1 kHz ± 10% (3 dB)	Within ± 1.85 kHz (60 dB) Within ± 2.4 kHz (70 dB)																																															
48 kHz	≥ 30 kHz (0.7 dB) 48 kHz ± 10% (3 dB)	Within ± 36 kHz (60 dB)																																															
Intrinsic distortion attenuation	Input level below 10 dBm: Single tone, 2nd and 3rd order respectively ≥ 70 dB (1 kHz to 12 MHz)																																																
IF rejection	≥ 70 dB (56.6 MHz, refer to full scale value) ≥ 80 dB (other frequencies)																																																
Image rejection	≥ 80 dB																																																
Phase jitter	Compatible with CCITT Rec. 0.91 and BSP 41009 (1) Input signal frequency range 1 kHz to 30 MHz (2) Input signal level range: -60 dBm to +10 dBm (3) Frequency response: 20 Hz to 300 Hz (4) Measuring accuracy: ± 10% + 0.5° p-p (5) Residual phase jitter: ≤ 0.5° p-p																																																
Weighted noise and notch filter	Weighting filter is compatible with CCITT Rec. P.53 (ML422C) or BSP 41009 C-message (ML422B) response. In selective mode, weighted noise and notch filter are superimposed on the 3.1 kHz channel filter response. In wideband mode, unit can be used as a normal psophometer. Notch filter gives more than 50 dB rejection of tone signal of 1010 Hz ± 15 Hz.																																																
Impulse noise	Compatible with CCITT Rec. 0.71 or BSP 41009 Time period: 1 to 99 minutes Threshold level setting: 1 dB step (≥ -80 dBm) Dead time: 125 msec. ± 25 msec. (ML422C) 143 msec. ± 25 msec. (ML422B) Maximum count: 999																																																
Signal search	Automatic search for unknown signals or "hot" tones on transmission systems. Threshold level range: -100 dBm to 0 dBm (BW 3.1 kHz) Threshold level accuracy: ± 2 dB (scale 20 dB) Dynamic range: ≥ 50 dB																																																

Continued on next page.

Remote control	Compatible with IEEE Standard 488-1978. Optional adapting connector for IEC 625-1 is available. Interface functions: SH1, AH1, T5, L3, SR1, RL1, PPO, DC1, DT0, C0.
Demodulator	Lower sideband (LSB), upper sideband (USB) Demodulated output frequency: 300Hz to 3400Hz (BW 3.1kHz) Demodulated output level: typically 0dBm to 600Ω (at 0dB meter indication) Output connector: suitable for SP-110
Output for recorder	Approximately 2V at 0dB meter indication Internal resistance: approx. 10kΩ Output connector: BNC female
Tracking output	Frequency range: 800Hz to 30MHz Output level: 0dBm (to 75Ω unbalanced) (Tracking output cannot be used during internal calibration)
External frequency reference input	The internal reference oscillator can be synchronized with an external signal. Frequency: 1, 2, 5, 10MHz Frequency accuracy: $\pm 1 \times 10^{-6}$ Level: 1 to 5Vp-p
Input connector	Unbalanced: BNC female Balanced: 3-pole CF connector**
Power	$\leq 145VA$
Ambient temperature, rated range of use	0° to 45° C
Dimensions and weight	177H, 426W, 450D mm, $\leq 20kg$
Accessories supplied	Two coaxial cables: 1 m One extender board (for use in maintenance and service)

*1 Balanced input impedances are as follows.

ML422B: 75Ω, 124Ω, 135Ω, 600Ω
ML422C: 75Ω, 135Ω, 150Ω, 600Ω

**2 3-pole CF connector can be replaced by I-214 type. (Option 12)

Specifications of ML422B/C options

- 12:** Modification of input connector (ML422C only)
Balanced input connectors are modified to I-214 type
- 31:** Modification of selective bandwidth
400Hz BW is installed instead of 48kHz BW
3dB bandwidth: 400Hz \pm 10%
60dB bandwidth: $\leq \pm 2kHz$
Frequency range is 10kHz to 30MHz.
Level range is -100dB to +30dBm
- 42:** Modification of FDM channel plan (ML422C only)
Bell System plan MMX2 is installed instead of CCITT
Rec. G332, plan 1A, G343 plan 1, and G334 plan 1
- 43:** Modification of FDM channel plan
CCITT Rec. G332 plan 2 is installed instead of standard plan.

Optional accessories

- GP-IB Bus Cable (1 m or 2 m in length)
- Connector: ICC-1 (IEC-IB → GP-IB)
ICC-2 (GP-IB → IEC-IB)
- Rack Flange Kit
- Front Handle Kit
- Front Cover
- Portable Test Rack
- Carrying Case
- MA45A High-Impedance Probe

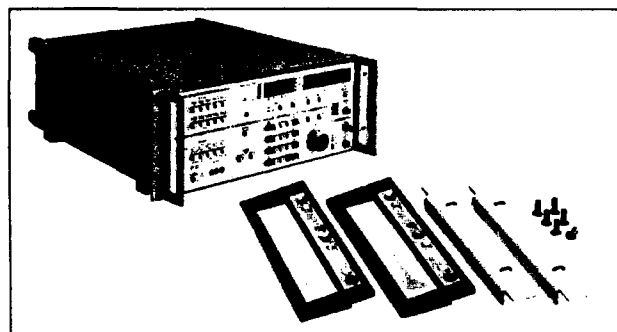

Rack flange kit

Options

- Option 11 = ICC-2 Transformer Connector (GPIB to IEC-IB)
- Option 21 = Modifies the 124 and 135 ohm balanced input frequency ranges

ANALOG TRANSMISSION CHARACTERISTICS MEASURING INSTRUMENTS

Level display	LED 5 digits, resolution: 0.01 dB (20 dB scale range), 0.1 dB (100 dB scale range) Units: dBm, dB (0.775 V), dB (X-R, relative to REF (R))		
Input impedance	(1) Unbalanced input (75 Ω) TERMINATED: Return loss ≥ 35 dB (50 Hz to 20 MHz), ≥ 25 dB (20 to 30 MHz) HIGH: 10 kΩ $\pm 10\%$ shunted by ≤ 80 pF (2) Balanced input TERMINATED: Return loss ≥ 30 dB, CMRR ≤ 80 dB HIGH: typically 2 kΩ at 2 MHz (75 Ω, 124 Ω, 135 Ω, 150 Ω) ¹ typically 15 kΩ at 120 kHz (600 Ω)		
Bandwidth and selectivity	Bandwidth	Pass bandwidth	
	20 Hz	≥ 6 Hz (0.5 dB), 16 Hz $\pm 20\%$ (3 dB)	Attenuation characteristic ± 35 Hz (45 dB), ± 70 Hz (60 dB), ± 2 kHz (80 dB)
	3.1 kHz	≥ 1 kHz (0.5 dB), 3.1 kHz $\pm 10\%$ (3 dB)	± 1.85 kHz (60 dB), ± 2.4 kHz (70 dB)
	48 kHz	≥ 30 kHz (0.7 dB), 48 kHz $\pm 10\%$ (3 dB)	± 36 kHz (60 dB)
Intrinsic distortion attenuation	Input level below 10 dBm: Single tone, 2nd and 3rd order respectively ≥ 70 dB (1 kHz to 12 MHz)		
IF rejection	≥ 70 dB (56.6 MHz, refer to full scale value), ≥ 80 dB (other frequencies)		
Image rejection	≥ 80 dB		
Phase jitter	Compatible with CCITT Rec. O.91 and BSP 41009 (1) Input signal frequency range: 1 kHz to 30 MHz (2) Input signal level range: -60 to +10 dBm (3) Frequency response: 20 to 300 Hz (4) Measuring accuracy: $\pm 10\% + 0.5^\circ$ p-p (5) Residual phase jitter: $\leq 0.5^\circ$ p-p		
Weighted noise and notch filter	The weighting filter is compatible with CCITT Rec. P.53 (ML422C) or BSP 41009 C-message (ML422B) response. In selective mode, weighted noise and notch filter are superimposed on the 3.1 kHz channel filter response. In wideband mode, unit can be used as a normal psophometer. The notch filter gives more than 50 dB rejection of tone signal of 1010 ± 15 Hz.		
Impulse noise	Compatible with CCITT Rec. O.71 or BSP 41009 Time period: 1 to 99 minutes Threshold level setting: 1 dB step (≥ -80 dBm) Dead time: 125 ± 25 ms (ML422C), 143 ± 25 ms (ML422B) Maximum count: 999		
Signal search	Automatic search for unknown signals or "hot" tones on transmission systems Threshold level range: -100 to 0 dBm (BW 3.1 kHz) Threshold level accuracy: ± 2 dB (scale 20 dB) Dynamic range: ≥ 50 dB		
Remote-control	Compatible with IEEE Standard 488-1978. Optional adapting connector for IEC 625-1 is available. Interface functions: SH1, AH1, T5, L3, SR1, RL1, PP0, DC1, DT0, CO.		
Demodulator	Lower sideband (LSB), upper sideband (USB) Demodulated output frequency: 300 to 3400 Hz (BW 3.1 kHz) Demodulated output level: typically 0 dBm to 600 Ω (at 0 dB meter indication) Output connector: suitable for SP-110		
Output for recorder	Approximately 2 V at 0 dB meter indication Internal resistance: approx. 10 kΩ Output connector: BNC female		
Tracking output	Frequency range: 800 Hz to 30 MHz Output level: 0 dBm (to 75 Ω unbalanced) (Tracking output cannot be used during internal calibration)		
External frequency reference input	The internal reference oscillator can be synchronized with an external signal. Frequency: 1, 2, 5, 10 MHz Frequency accuracy: $\pm 1 \times 10^{-6}$ Level: 1 to 5 Vp-p		
Input connector	Unbalanced: BNC female, Balanced: 3-pole CF connector ²		
Power	AC 100 V, ≤ 135 VA		
Ambient temperature, rated range of use	0° to 45°C		
Dimensions and mass	177H x 426W x 451D mm, <20 kg		

¹ Balanced input impedances are as follows:

ML422B: 75 Ω, 124 Ω, 135 Ω, 600 Ω

ML422C: 75 Ω, 135 Ω, 150 Ω, 600 Ω

² 3-pole CF connector can be replaced by I-214 type. (Option 12)

Specifications of ML422B/C options

12: Modification of input connector (ML422C only)

Balanced input connectors are modified to I-214 type

31: Modification of selective bandwidth

400 Hz BW is installed instead of 48 kHz BW

3 dB bandwidth: 400 Hz $\pm 10\%$

60 dB bandwidth: $\leq \pm 2$ kHz

Frequency range: 10 kHz to 30 MHz

Level range: -100 to +30 dBm

41: Modification of FDM channel plan

CCITT Rec. G.332 plan 1A, G.343 plan 1 and G.334 plan 1 are installed instead of Bell System plan MMX.

42: Modification of FDM channel plan (ML422C only)

Bell System plan MMX2 is installed instead of CCITT Rec. G.332, plan 1A, G.343 plan 1, and G.334 plan 1.

43: Modification of FDM channel plan

CCITT Rec. G.332 plan 2 is installed instead of standard plan.

ANALOG TRANSMISSION CHARACTERISTICS MEASURING INSTRUMENTS

Ordering Information

Please specify model/order number, name and quantity when ordering.

Model/Order No.	Name	Remarks
ML422B ML422C	Main frame Selective Level Meter Selective Level Meter	50 Hz to 30 MHz 50 Hz to 30 MHz
J0116A J0017 J0247 F0023 W0206AE W0206BE	Standard accessories Coaxial Cord, 1 m: 1 pc Power Cord, 2.5 m: 1 pc No. 110 Plug: 1 pc Fuse, 3.15 A: 2 pcs ML422B/C Operation Manual: 1 copy ML422B/C Service Manual: 1 copy	3CZ-P---3CZ-P SS-156 MF51NN250V3.15AAC05
ML422B/C-12 ML422B/C-31 ML422B/C-41 ML422B/C-42 ML422B/C-43	Options Balanced input connectors are modified to I-214 type 400 Hz BW is installed instead of 48 kHz BW Selected FDM channel plan is modified to that of ML422C Selected FDM channel plan is modified to that of ML422B Selected FDM channel plan is modified to CCITT Rec. G.332 Plan 2 and G.343 Plan 1	ML422C only ML422B only ML422C only
J0007 J0008 J0010 J0011 B0020 MA45A MA430A MA431A J0162A J0162B J0163 J0164 J0168A J0168B B0043 B0038 MB23A MB24A B0209 B0210 B0211 B0212 B0020	Optional accessories GP-1B Cable, 1 m GP-1B Cable, 2 m ICC-1 Transformer Connector ICC-2 Transformer Connector Front Cover Probe Probe Tip Adaptor Probe Tip Adaptor Balanced Cord, 1 m, Siemens Type Balanced Cord, 2 m, Siemens Type Balanced Cord, 1 m, Siemens Type/I-214 Type Balanced Cord, 2 m, Siemens Type/I-214 Type Balanced Cord, 1 m, I-214 Type Balanced Cord, 2 m, I-214 Type Rack Mount Kit Front Handle Kit Portable Test Rack Portable Test Rack Carrying Case Carrying Case Carrying Case Carrying Case Front Cover	408JE-101 408JE-102 IEC-1B→GP-1B GP-1B→IEC-1B BNC-P BNC-R M3912---M3912 M3912---M3912 M3912---M-214S-SP M3912---M-214S-SP M-214S-SP---M-214S-SP M-214S-SP---M-214S-SP For ML422B, without casters For ML422B, with casters For ML422C, without casters For ML422C, with casters